

Document Name:	GA02118 User Manual BV20
Document Version:	1.0
Date of Release:	13-04-2018

TABLE OF CONTENTS

1	DOCUMENT INTRODUCTION.....	4
1.1	RELATED DOCUMENTS.....	4
1.2	MANUAL AMENDMENTS.....	4
1.3	COPYRIGHT.....	4
1.4	LIMITED WARRANTY.....	4
1.5	PRODUCT SAFETY INFORMATION.....	5
1.6	DISCLAIMER.....	5
2	PRODUCT INTRODUCTION.....	7
2.1	GENERAL DESCRIPTION.....	7
2.2	KEY FEATURES.....	7
2.3	TYPICAL APPLICATIONS.....	7
2.4	COMPONENT OVERVIEW.....	7
2.4.1	<i>Module Options</i>	8
2.5	BEZEL OPTIONS.....	8
2.6	CASHBOX OPTIONS.....	8
3	MECHANICAL INSTALLATION.....	9
3.1	COMPATIBILITY.....	9
3.1.1	<i>Hardware Compatibility</i>	9
3.1.1.1	Machine Mounting.....	9
3.1.1.2	Machine Interfacing.....	9
3.1.1.3	Power Supply.....	9
3.1.2	<i>Software Compatibility</i>	10
3.1.2.1	Interface Protocols.....	10
3.1.2.2	Re-programming.....	10
3.2	ENTRANCE WIDTH SETTINGS.....	11
3.2.1	<i>66mm width setting</i>	11
3.2.2	<i>72-mm width setting</i>	11
3.3	CASHBOX/BASEPLATE MOUNTING.....	12
3.3.1	<i>Cashbox/Baseplate Fitting</i>	12
3.4	MACHINE MOUNTING.....	12
3.4.1	<i>BV20 Position</i>	12
3.4.2	<i>Earth Bonding</i>	13
3.4.3	<i>Screw Specifications</i>	13
4	SOFTWARE INSTALLATION AND CONFIGURATION.....	14
4.1	INTRODUCTION.....	14
4.2	SOFTWARE DOWNLOADS.....	14
4.3	DRIVERS.....	14
4.4	DATASET/FIRMWARE PROGRAMMING.....	14
4.4.1	<i>Validator Manager</i>	14
4.4.1.1	General Description.....	14
4.4.1.2	System Requirements.....	14
4.4.1.3	Hardware Setup.....	15
4.4.1.4	Switching to Programming Mode (SSP).....	15
4.4.1.5	Programming the device.....	16
4.4.2	<i>DA3</i>	17
4.4.2.1	General Description.....	17
4.4.2.2	System Requirements.....	17



[<< Back to Contents](#)

4.4.2.3	Re-programming via DA3	18
4.4.3	<i>Remote Updates</i>	19
4.4.4	<i>Configuration Card</i>	20
4.4.4.1	General Description	20
4.4.4.2	Re-programming via Configuration Card.....	20
5	PROTOCOLS AND INTERFACING	21
5.1	INTRODUCTION.....	21
5.2	SSP AND ESSP	22
5.2.1	<i>General Description</i>	22
5.2.2	<i>Pin Assignments</i>	22
5.2.3	<i>Setup Examples</i>	23
5.3	ccTALK®	24
5.3.1	<i>General Description</i>	24
5.3.2	<i>Pin Assignments</i>	24
5.3.3	<i>ccTalk® DES Encryption</i>	25
5.3.4	<i>Setup Example Drawing/s</i>	25
5.4	SIO AND SI2.....	26
5.4.1	<i>General Description</i>	26
5.4.2	<i>Pinout</i>	29
5.5	MDB	30
5.5.1	<i>General Description</i>	30
5.5.2	<i>Pinout</i>	31
5.5.3	<i>IF5 Interface</i>	32
5.5.4	<i>MDB PSU</i>	32
5.5.5	<i>Setup Example Drawing/s</i>	33
5.6	PARALLEL	35
5.6.1	<i>General Description</i>	35
5.6.2	<i>Pinout</i>	35
5.6.3	<i>Inhibit Control</i>	35
5.6.4	<i>Escrow Control</i>	36
5.6.5	<i>Busy Control</i>	36
5.6.6	<i>Low Power Mode</i>	36
5.6.7	<i>IF10 Interface</i>	36
5.7	BINARY	37
5.7.1	<i>General Description</i>	37
5.7.2	<i>Pinout</i>	37
5.7.3	<i>Inhibit Control</i>	38
5.7.4	<i>Escrow Control</i>	38
5.7.5	<i>Busy Control</i>	38
5.7.6	<i>Low Power Mode</i>	38
5.7.7	<i>IF9 Interface</i>	38
5.8	PULSE.....	39
5.8.1	<i>General Description</i>	39
5.8.2	<i>Pinout</i>	39
5.8.3	<i>Inhibit Control</i>	39
5.8.4	<i>Escrow Control</i>	40
5.8.5	<i>Busy Control</i>	40
5.8.6	<i>Low Power Mode</i>	40
5.8.7	<i>Credit Hold Function</i>	40
5.8.8	<i>IF15 Interface</i>	41
6	ROUTINE MAINTENANCE	42
6.1	INTRODUCTION.....	42
6.2	RECOMMENDED CLEANING INTERVALS	42
7	FIRST LEVEL SUPPORT	43
7.1	BEZEL LED FLASH CODES	43
7.2	CONFIGURATION BUTTON FUNCTIONS.....	43



[<< Back to Contents](#)

7.3	CHECKING POWER AND COMMUNICATION CONNECTIONS.....	43
7.4	PROGRAM CHECK PROCEDURE	44
8	SECOND LEVEL SUPPORT	45
8.1	CLEARING A JAM.....	45
8.2	CLEANING THE BV20	46
8.3	CLEARING A CHECKSUM ERROR	47
8.4	RE-INITIALISATION OF THE SENSORS.....	48
9	TECHNICAL DATA	51
9.1	DIMENSIONS.....	51
9.2	WEIGHT.....	51
9.3	ENVIRONMENTAL REQUIREMENTS.....	51
9.4	POWER REQUIREMENTS.....	51
9.4.1	<i>Supply Voltages</i>	51
9.4.2	<i>Supply Currents</i>	51
9.4.3	<i>Power Supply Guidance</i>	52
9.5	INTERFACE LOGIC LEVELS.....	52
9.6	RELIABILITY DATA	52
9.7	MEDIA REQUIREMENTS.....	52
10	COMPLIANCES AND APPROVALS	53
10.1	EC DECLARATION OF CONFORMITY	53
11	APPENDIX	54
11.1	CABLE DRAWINGS	54
11.2	CONNECTOR SPECIFICATIONS	56
11.3	SWITCHING TO PROGRAMMING MODE (SSP)	56
11.4	FREE FALL CASHBOX ADVICE	56
11.5	CCTALK DES ENCRYPTION – TRUSTED MODE.....	56
11.6	ESCROW CONTROL	57
11.6.1	<i>Escrow Timing Diagram</i>	58
11.7	LOW POWER MODE TIMING DIAGRAM.....	59
11.8	FILE NAMING CONVENTION	60



1 DOCUMENT INTRODUCTION

1.1 Related Documents

This document should be read together with the following:

For SSP/eSSP:

Protocol Manual – SSP (GA138) : SSP Interface Protocol Specification for integration

SSP Implementation Guide (GA973) : Information for programmers and integrators

For other third party interface protocols please contact support@innovative-technology.com.

1.2 Manual Amendments

Rev.	Date	Amendment Details	Issued by
1.0	22/06/2017	First Issue	MC

1.3 Copyright

This manual set is Copyright © Innovative Technology Ltd. 2016. No part of this publication may be reproduced in any form or by any means used to make any derivative such as translation, transformation, or adaptation without permission from Innovative Technology Ltd. The contents of this manual set may be subject to change without prior notice.

1.4 Limited Warranty

Innovative Technology Ltd warrants each of its hardware products to be free from defects in workmanship and materials under normal use and service for a period commencing on the date of purchase from Innovative Technology Ltd or its Authorized Reseller, and extending for the length of time stipulated by Innovative Technology Ltd.

A list of Innovative Technology Ltd offices can be found in every section of this manual set. If the product proves defective within the applicable warranty period, Innovative Technology Ltd will repair or replace the product. Innovative Technology Ltd shall have the sole discretion whether to repair or replace, and any replacement product supplied may be new or reconditioned.

The foregoing warranties and remedies are exclusive and are in lieu of all other warranties, expressed or implied, either in fact or by operation of law, statutory or otherwise, including warranties of merchantability and fitness for a particular purpose.

Innovative Technology Ltd shall not be liable under this warranty if it's testing and examination disclose that the alleged defect in the product does not exist or was caused by the customer's or any third person's misuse, neglect, improper installation or testing, unauthorized attempts to repair, or any other cause beyond the range of the intended use. In no event will Innovative Technology Ltd be liable for any



[<< Back to Contents](#)

damages, including loss of profits, cost of cover or other incidental, consequential or indirect damages arising out the installation, maintenance, use, performance, failure or interruption of an Innovative Technology Ltd product, however caused.

1.5 Product Safety Information

Throughout this user manual, we may draw your attention to key safety points that you should be aware of when using or maintaining the product.

These safety points will be highlighted in a box, like this:

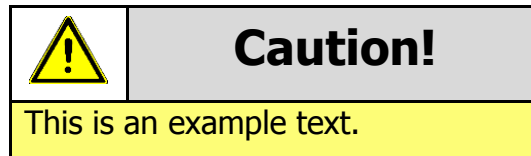

This user manual and the information it contains is only applicable to the model stated on the front cover, and must not be used with any other make or model.

1.6 Disclaimer

Innovative Technology Ltd is not responsible for any loss, harm, or damage caused by the installation and use of this product. This does not affect your local statutory rights. If in doubt please contact Innovative Technology for details of any changes.

Innovative Technology Ltd has a policy of continual product improvement. As a result the products supplied may vary from the specification described here.

Innovative Technology Ltd does not accept liability for any errors or omissions contained within this document. Innovative Technology Ltd shall not incur any penalties arising out of the adherence to, interpretation of, or reliance on, this standard.





Safety Notice! Read before using this product!

Safety Notice - Warning. Ensure power is removed before allowing access to the inside of this product. Ensure any static build up is discharged before allowing access to any part of this product or media contained. Always earth this product/base plate in accordance with the manual.

For use only in or with complete equipment where the acceptability of the combination is determined by UL LLC. When installed in an end-product, consideration must be given to the following:

- The power supply terminals and/or connectors are: Not investigated for field wiring
- The investigated Pollution Degree is: 2
- The following end-product enclosures are required: Mechanical, Fire

Sicherheitshinweis – Warnung: Es muss sichergestellt werden, dass das Gerät von der Versorgungsspannung getrennt wird, bevor ein Eingriff in das Innere des Gerätes erfolgt. Es muss sichergestellt werden, dass jegliche statische Aufladung des Gerätes entladen wird, bevor auf das Gerät oder auf innerhalb des Gerätes befindliche Objekte zugegriffen wird. Die Erdung des Gerätes muss immer gemäß Handbuch erfolgen.

Nur für die Verwendung in oder mit kompletter Ausstattung, dessen Eignung und Kombination von der UL LLC ermittelt wurde. Bei der Installation in einem Endprodukt, muss folgendes berücksichtigt werden:

- Die Spannungsversorgungsklemmen und/oder Verbinder sind: Feldverkabelung wurde nicht untersucht
- Der untersuchte Verschmutzungsgrad ist: 2
- Folgende Anforderungen an die Gehäuse des Endproduktes sind gefordert: Mechanisch, Feuer

Aviso de seguridad: Asegúrese de que la alimentación está desconectada y de que toda la energía estática es descargada antes de manipular este producto. Conecte a tierra la chapa base de la manera que se indica en el manual.

Solo para uso con dispositivos con los cuales la compatibilidad ha sido certificada por UL LLC. Tras su instalación en producto acabado, tener en cuenta lo siguiente:

- Los conectores y terminales de alimentación son: No se ha investigado/especificado cableado externo.
- El grado de contaminación determinado es: 2
- Los siguientes manuales/certificados de producto final son requeridos: Mecánico, Fuego

Avis de sécurité : Assurez-vous que l'alimentation est coupée et que toute l'énergie statique est déchargé avant de manipuler ce produit. Connecter à la terre, la plaque de base à la manière indiquée dans le manuel.

A utiliser Seulement avec les dispositifs dont la compatibilité a été certifiée par UL LLC. Après son installation dans le produit fini, prendre en considération ce qui suit:-

- Les connecteurs et les bornes d'alimentation sont : cela n'a pas été étudié/spécifié câblage externe.
- Le degré de contamination déterminé est: 2
- Les manuels suivants / les certificats du produit final sont nécessaires : mécanique, incendie

Bezpečnostní upozornění. Před manipulací uvnitř tohoto produktu se ujistěte, že je produkt odpojen od zdroje elektrického napětí. Ujistěte se, že jakýkoliv elektrostatický náboj byl vybit před manipulací s jakoukoliv částí tohoto produktu nebo obsaženým médiem. Vždy uzemněte tento produkt/základovou desku v souladu s návodem.

Pouze pro použití v nebo s kompletním vybavením, kde je přijatelnost kombinace určena UL LLC. Při instalaci v konečném produktu je třeba zvážit následující:

- Napájecí svorky a/nebo konektory: Nejsou sledované pro externí kabeláž
- Sledovaný stupeň znečištění je: 2
- Následující krytí konečného produktu jsou požadované: Mechanické, Protipožární



2 PRODUCT INTRODUCTION

2.1 General Description

The BV20 is a compact, light-weight bill acceptor ideal for amusement and low value vending applications. Proven field reliability, quick transactions and easy maintenance make the unit future proof.

Exceptional value, the BV20 allows a bill acceptor to be installed for the same price as a coin mech.

2.2 Key Features

- Compact bill acceptor
- Simple design
- Exceptional value
- Ideal for amusement, kiddie rides & jukebox applications

2.3 Typical Applications

- Gaming
- Amusement
- Vending

2.4 Component Overview

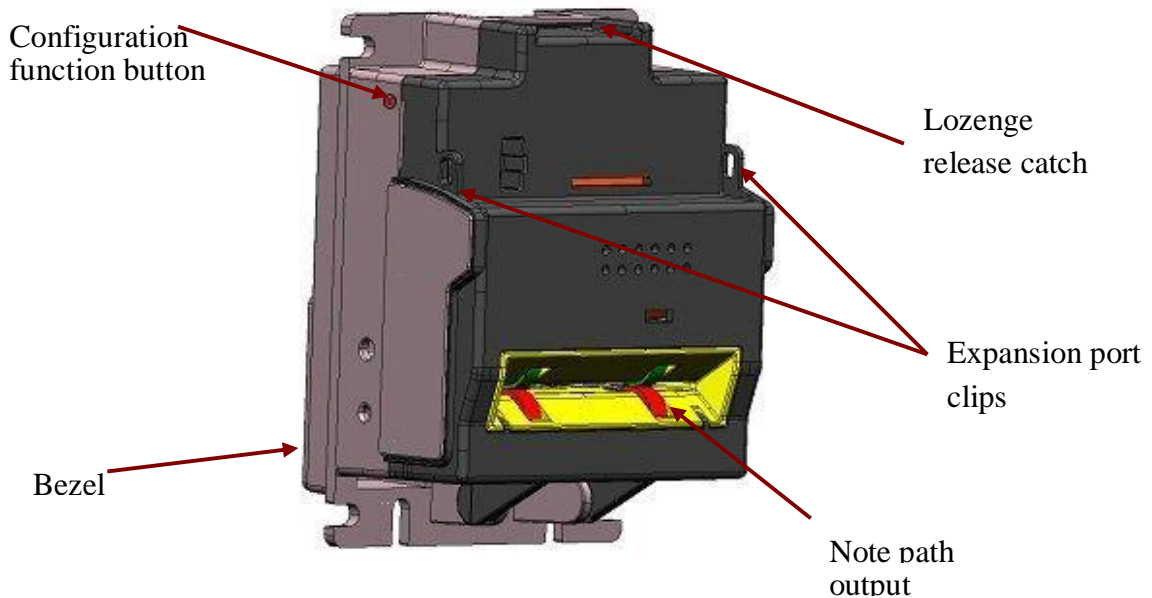

[<< Back to Contents](#)

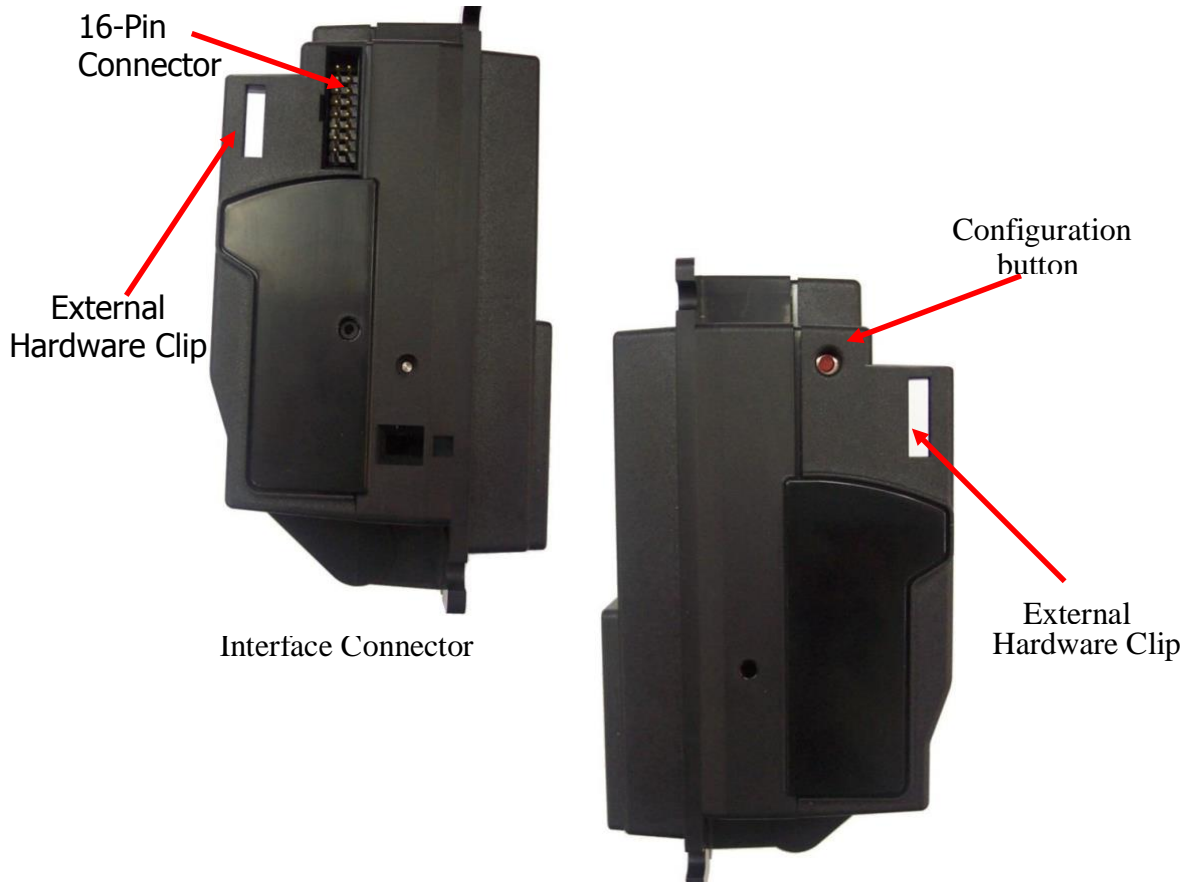

2.4.1 Module Options

ITL Part Number	Description	Details
BV20110VPSU	BV20 110V Power Supply Unit	http://innovative-technology.com/shop/accessories/bv20-110v-power-supply-unit-detail

2.5 Bezel Options

The BV20 validator is available with either 66mm or 72mm Bezel. Datasets can only be downloaded to a BV20 with the correct bezel width for the currency. For example a USD dataset can only be downloaded to a 66mm BV20. A Euro dataset can only be downloaded to a 72mm BV20.

2.6 Cashbox Options

The BV20 validator is designed to have no built-in cashbox. On BV20 installation, banknotes being validated by BV20 validator must be able to be transported behind the validator with no obstructions. Banknotes accepted must be able to free fall until the banknote is not in any contact with BV20 validator body.



3 MECHANICAL INSTALLATION

3.1 Compatibility

3.1.1 Hardware Compatibility

3.1.1.1 Machine Mounting

Assuming the suitable bezel (and cashbox) type has been ordered the BV20 can be used as fitting replacement for the following products:

- BV20

The BV20 may not be used as fitting replacement for the following products:

- BV50
- BV100
- NV150
- NV9 USB
- NV10 USB
- NV200

Innovative Technology Ltd. has a policy of continuous product improvement. Due to design changes older model or product bezels (and cashboxes) may not be compatible with the BV20. However, new product deliveries always include a bezel (and cashbox) that must be used.

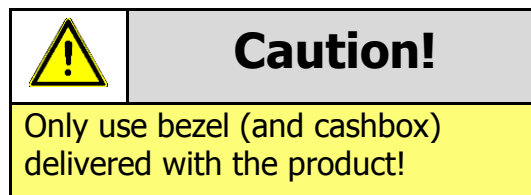

3.1.1.2 Machine Interfacing

By design the BV20 is pin to pin compatible with the suitable fitting replacement products listed above. No changes to existing machine harnessing are required.

3.1.1.3 Power Supply

It is vital that the BV20 is connected to a power supply being able to provide the required power environment. A weak power supply causes malfunctioning of the BV20 such like note rejects or missing credits. If the BV20 is used as a fitting replacement for an older model or product we recommend to check the power supply specifications of the machine. The power supply of the machine might be designed for the older model or product but not suitable for the BV20. The BV20 might have higher power consumption. Refer to [9.4](#) for full power requirement details of the BV20.

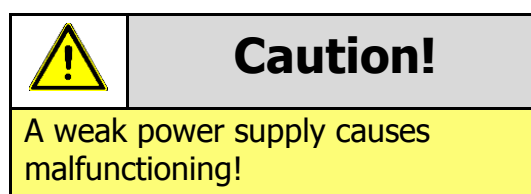

3.1.2 Software Compatibility

3.1.2.1 Interface Protocols

When using the BV20 as a fitting replacement for an older model or product some events such like credits may be given earlier. This is due to improved firmware routines and faster motors being used. This may cause missing events such like credits in those host machines where timeouts are defined for the older model or product. Please contact the machine manufacturer for full compatibility of the BV20.

	Caution!
Timing issues may cause missing events such like credits!	

3.1.2.2 Re-programming

For re-programming the BV20 always use the latest version of Validator Manager available for download on our website. Older versions may not support the BV20. For further details on Re-programming the BV20 refer to [4.2](#).

	Caution!
Older versions of Validator Manager may not support the BV20!	

[<< Back to Contents](#)

3.2 Entrance Width settings

BV20 has 66mm and 72mm bezel width built-in settings available. The two bezels width are not interchangeable.

3.2.1 66mm width setting

1. Check imprinted sizing on top right corner "66mm"



-
2. Use **66mm** [dataset file](#)

File can be downloaded from ITL website/ downloading section

3.2.2 72-mm width setting

1. Check imprinted sizing on top right corner "72 mm"



-
2. Use **72mm** [dataset file](#)

File can be downloaded from ITL website/ downloading section

[<< Back to Contents](#)

3.3 Cashbox/Baseplate Mounting

3.3.1 Cashbox/Baseplate Fitting

BV20 is designed to have no built-in cashboxes. Sufficient space behind BV20 must be kept free at all time for accepted banknotes and banknote in escrow to free fall during operation.

3.4 Machine Mounting

3.4.1 BV20 Position

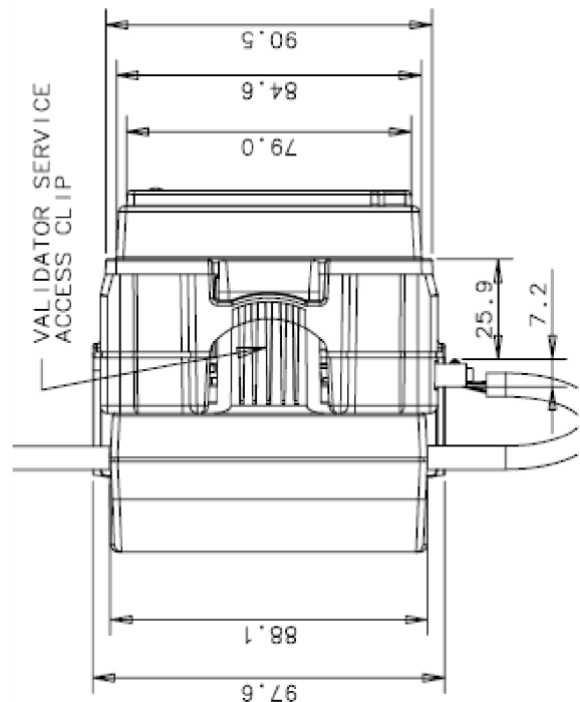
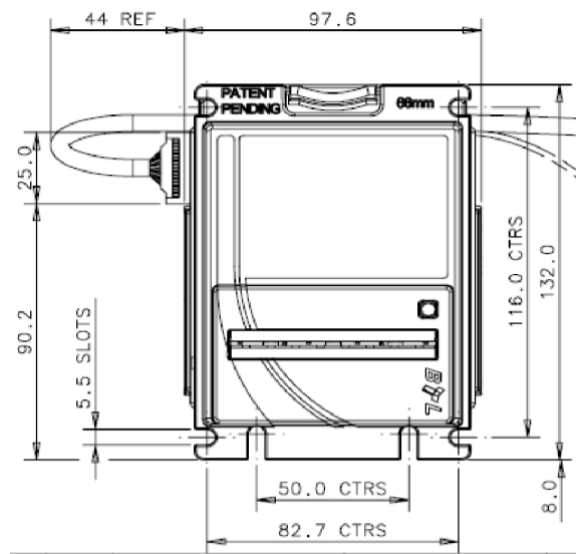
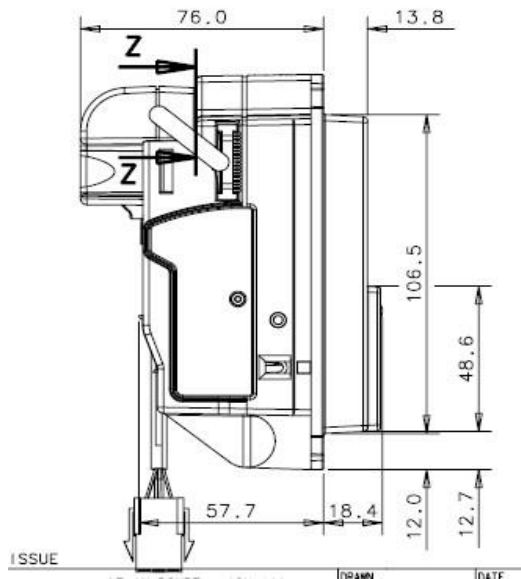

[<< Back to Contents](#)

3.4.2 Earth Bonding

It is very important that the BV20 is properly bonded to earth as described in [3.4.1](#). Lack of proper bonding can cause communication issues and other failures.

	Caution!
Lack of proper earth bonding causes failures!	

3.4.3 Screw Specifications

The scope of delivery does not include screws for machine mounting. See table below for screw specification reference.

Type	Head Diameter		Head Height		Bolt Diameter		Bolt Length	
	Min	Max	Min	Max	Min	Max	Min	Max
Flat Head	7	-	2	-	2.5	4.5	15	42
Pan Head	7	-	2	-	2.5	4.5	15	42



4 SOFTWARE INSTALLATION AND CONFIGURATION

4.1 Introduction

The BV20 leaves the factory pre-programmed with the latest dataset and firmware files. However, it is important to ensure your device is kept up to date with the latest dataset and firmware. This section will give you a brief overview of the various update possibilities with the BV20. For detailed instructions please refer to the relevant manual package supplied with the software or contact support@innovative-technology.com.

4.2 Software Downloads

All software from Innovative Technology Ltd is free of charge and can be downloaded from the website www.innovative-technology.com/support/secure-download once registered and logged in. If you are not registered, please create an account via the Create an account form. A confirmation email will be sent to the registered email address once all contact details have been successfully submitted.

4.3 Drivers

The ITL drivers allow you to connect any of our validators to a compatible Windows device. If you are connecting via an IF17 then you will not need to follow this process as they are signed Microsoft Drivers and should install automatically. If this isn't the case or your computer is disconnected from the network, there is a standalone package included within the driver downloads.

4.4 Dataset/Firmware Programming

4.4.1 Validator Manager

4.4.1.1 General Description

Validator Manager is a utility which allows the user to reprogram any of ITL's validators, hoppers as well as coin and note recycler. Please note that admin rights are required during installation. The validator must be in SSP for the Validator Manager to detect the device.

4.4.1.2 System Requirements

- Windows XP SP3 or above
- .Net Framework 4
- 256mb ram
- 50mb hard disk free
- Connected BV20 with active com port

	Caution!
We have seen instances where one of the dll's (itdata1.dll) used in Validator Manager are flagged as a Trojan, this is a false positive and if this happens you will need to add a rule to your antivirus to allow the file to run.	



[<< Back to Contents](#)

4.4.1.3 Hardware Setup

Connect the [power supply cable](#) to the [DA2/IF17](#). Connect the [USB cable](#) to the [DA2/IF17](#) and to your computer or laptop. Connect the [CN00174 cable](#) to Validator and [DA2/IF17](#).

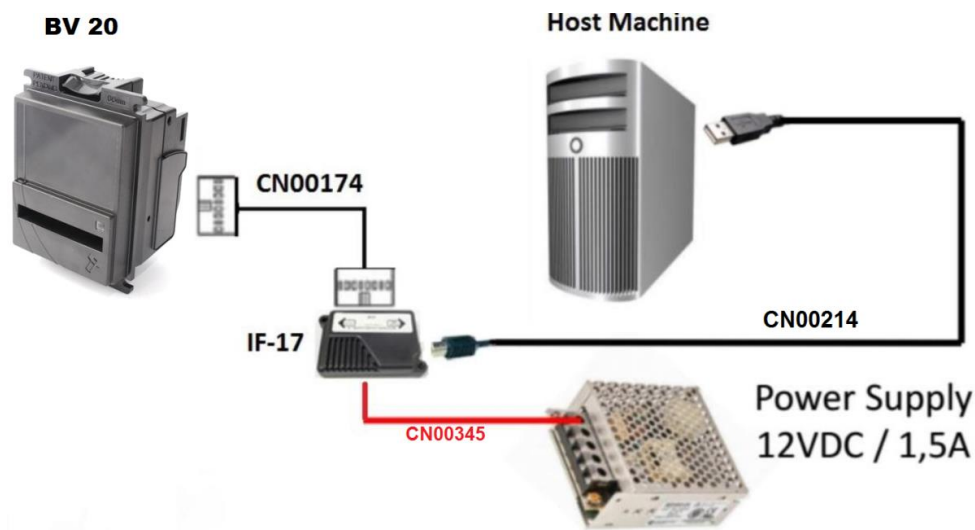

4.4.1.4 Switching to Programming Mode (SSP)

Before programming via the Validator Manager software tool, the BV20 needs to be switched to its programming mode (SSP interface). Please refer to [11.3](#) for the procedure for doing this.

[<< Back to Contents](#)

4.4.1.5 Programming the device

Once you have switched the unit into SSP, open Validator Manager and click detect devices. This will scan all active com ports for a unit, if your BV20 fails to connect please ensure the correct drivers are installed and the unit is in SSP.

By selecting the Program tab, you can reprogram the BV20. To begin the upload, click open file, then browse to the file location (usually Downloads) before clicking OK.

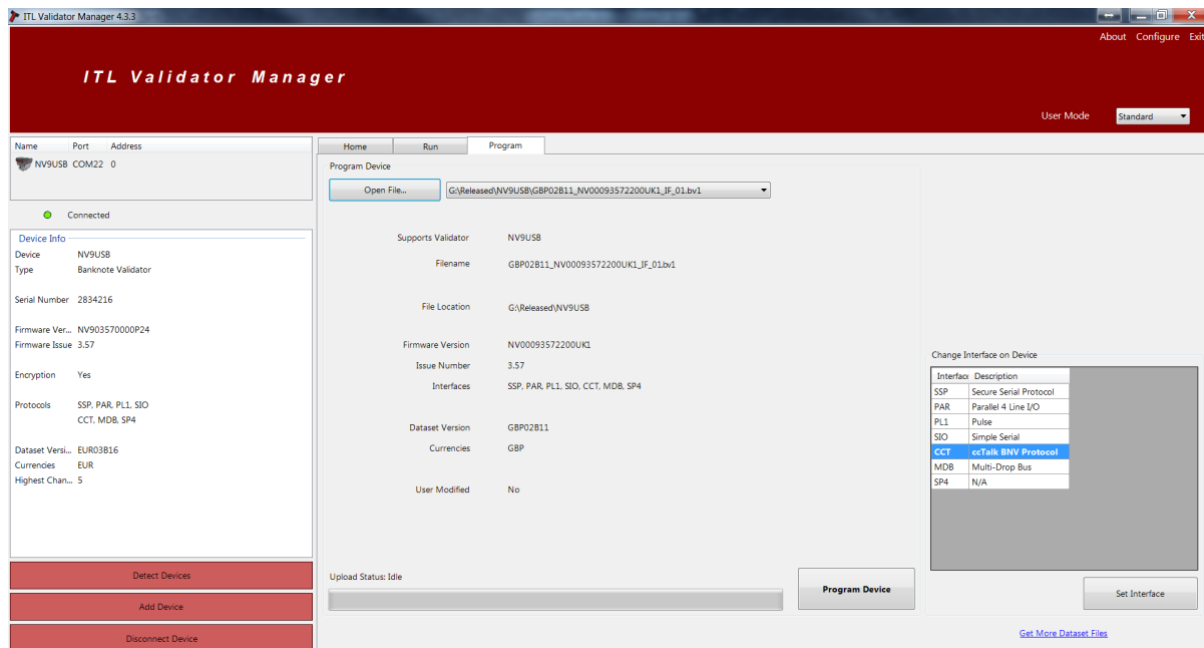

Once the file has been selected its information will be populated and the Program device tab will become active. Finally hit 'Program Device', the unit's bezel will now begin to flash signaling the update has begun.

	<h2>Caution!</h2>
<p>Interrupting the download process can result in the unit entering a non-functional state, once the process has started it cannot be halted.</p>	

When completed the unit will restart and a pop up box will appear saying Device Programming Complete.



[<< Back to Contents](#)

4.4.2 DA3

4.4.2.1 General Description

The DA3 is a hand-held validator programming system that enables the user to re-program ITL banknote validators in the field, without the use of a PC. Dataset and firmware files for different validator models can be stored on the DA3. Once programmed the user can update or override existing software as well as test the functionality of the validator, away from the host machine.



4.4.2.2 System Requirements

- Windows XP SP3 or above
- .Net Framework 4
- 256mb ram
- 50mb hard disk free
- Connected DA3 with active com port
- Data Flash Card (PA01121) **optional**

[<< Back to Contents](#)

4.4.2.3 Re-programming via DA3

1. Open Device Programming System and add the files you will use. Set "Match" update mode if you want to update current BV20 dataset after comparing datasets or "override" update mode, which will reprogram unit with chosen file and interface not depending on what is downloaded at the moment:

ITL DA3 connected. [Change DA3 firmware version](#)

Item	Value
Serial number	0
Firmware version	DA31001212298000
Loaded files	0

DA3 files...

Device	Dataset	Firmware	Update mode	I/F after update

Import a file

Your library files... Double click to edit and drag and drop to DA3.

Device	Country	Dataset	Firmware	Update mode	Available interfaces	I/F after update
BV20	AUSTRALIA	AUD03205	419	Match	SSP,PAR,PL1,SIO,CCT,MDB,SP4	N/A
BV20ST	AUSTRALIA	AUD03J05	419	Match	SSP,PAR,PL1,SIO,CCT,MDB,SP4	N/A

BV20ST 419 AUSTRALIA AUD03J05

Set Options

Interface code	Description	Option	Value
<input checked="" type="checkbox"/> SSP	Secure Serial Protocol	Strim function	No change
<input type="checkbox"/> PAR	Parallel 4 Line I/O	Program card	No change
<input type="checkbox"/> PL1	Pulse Output	PSU Monitor	No change
<input type="checkbox"/> SIO	Simple Serial	Channel Inhibits	No change
<input type="checkbox"/> CCT	ccTalk BNV Protocol	Stacker retry time	No change
<input type="checkbox"/> MDB	Multi-Drop Bus vending	SSP Bus Address	No change
<input type="checkbox"/> SP4	Special Pulse Output	eSSP Mandatory	No change

Update mode

Match

Override

Save Cancel

2. Drag and drop dataset for updating I left part of programming and press "update files":

ITL DA3 connected. [Change DA3 firmware version](#)

Item	Value
Serial number	0
Firmware version	DA31001212298000
Loaded files	0

Your Firmware files for update...

Device	Dataset	Firmware	Update mode	I/F after update
BV20ST	AUD03J05	419	Override	SSP

Free space: 7.66 M bytes

DA3 Card A Card B

Update Files



[<< Back to Contents](#)

3. Connect BV20 to DA3 VALIDATOR port.
Connect computer/ host machine to DA3 HOST MACHINE port:



4. Using small button choose MATCH DOWNLOAD or OVERRIDE DOWNLOAD depending on requirements, then press big button and downloading process will begin.

After, the BV20 restart and DA3 button become green colour meaning successful reprogramming.

The table below shows an explanation of error codes displayed on the Mode Indicator LED's if the center RUN button changes colour to red. The flash code is shown by a long flash then a number of short flashes:

Cause of failure (number of short flashes)	Cause of failure
2	No validator connection found
3	No valid download files found
4	Download fail
5	Memory card fail

All the details of DA3 using could be found in [ITL Software Manual](#).

4.4.3 Remote Updates

The BV20 validator supports remote updating.

For SSP protocol, the procedure of updating is described in Section 10 of SSP Implementation Guide ([GA973](#)).

For remote updating in ccTalk, please contact support@innovative-technology.com



	Caution!
This option is only available for SSP and ccTalk protocols	

4.4.4 Configuration Card

4.4.4.1 General Description

Configuration Card allows user to change configuration options/ protocol parameters without PC or DA3.

4.4.4.2 Re-programming via Configuration Card

Following the instruction of [Configuration Card](#). Manually print and cut off Configuration card (depending on bezel width 66 or 72mm). Power on the BV20 and wait until the BV20 idles. Press the BV20 configuration button once and enter filled configuration card to validator for changing options/ protocol.

5 PROTOCOLS AND INTERFACING

5.1 Introduction

The BV20 supports standard industry protocols. Interfaces that are not listed may be available upon request. For any queries regarding interfaces that are not listed please contact support@innovative-technology.com.

	Caution!
The use of an encrypted protocol (preferable eSSP) is strongly recommended to achieve the highest security!	

[<< Back to Contents](#)

5.2 SSP and eSSP

5.2.1 General Description

Smiley® Secure Protocol (SSP) and Encrypted Smiley® Secure Protocol (eSSP) are field proven secure interfaces specifically designed by Innovative Technology Ltd. to address the problems by cash handling systems in gaming machines. Problems such as acceptor swapping, re-programming acceptors and line tapping are all addressed. This interface is recommended for all new designs. Innovative Technology Ltd. provides full SDK packages upon request including Interface Specification, Implementation Guide as well as source code examples for C++, C#.NET and Linux. Please contact support@innovative-technology.com for further information.

5.2.2 Pin Assignments

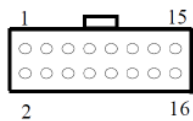

Pin	Name	Type	Description
1	Vend 1	Output	Serial Data Out (Tx)
2	Vend 2	Output	DA3 Data Logging
3	Vend 3	Output	Not Used
4	Vend 4	Output	Not Used
5	Inhibit 1	Input	Serial Data In (Rx)
6	Inhibit 2	Input	Not Used
7	Inhibit 3	Input	Not Used
8	Inhibit 4	Input	Not Used
9	Busy	Output	Not Used
10	Escrow	Input	Not Used
11	Factory Use Only		Factory Use Only
12	Factory Use Only		Factory Use Only
13	Factory Use Only		Factory Use Only
14	Factory Use Only		Do not connect
15	+ Vin	Power	+12VDC Supply
16	0V	Power	0V Supply (GND)

	Caution!
+12VDC and 0V (GND) must always be connected.	



[<< Back to Contents](#)

5.2.3 Setup Examples

The drawings below highlights how to connect the BV20 to an SSP or eSSP host machine using available cables and interfaces from Innovative Technology Ltd. For cable drawings please refer to [Appendix XYZ](#).

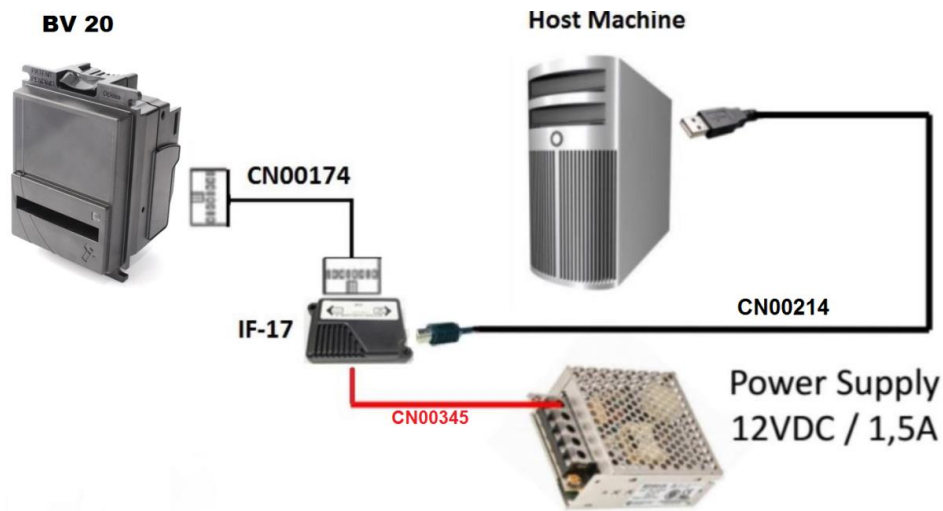

IF17 or other additional Setup Drawing 2 here

Type	ITL Part Number	Description	Details
Cable	CN00174	Ribbon Cable	http://www.innovative-technology.com/shop/cables/dual-essp-interface-for-smart-hopper-a-smart-payout-detail
Cable	CN00345	DA3 / IF17 / IF18 Power Cable	http://innovative-technology.com/shop/cables/da3-if17-if18-power-cable-detail
Cable	CN00214	USB Type A to B	http://www.innovative-technology.com/shop/cables/usb-a-to-b-cable-assembly-detail
Interface	IF17	TTL to USB Converter	http://www.innovative-technology.com/shop/accessories/if17-interface-converter-detail



[<< Back to Contents](#)

5.3 ccTalk®

5.3.1 General Description

ccTalk® is a serial communications protocol designed by Money Controls to allow 3-wire interfacing between a host and cash handling peripherals. Please contact support@innovative-technology.com for further information.

	Caution!
Innovative Technology Ltd. provides full SDK packages including Interface Specification, Implementation Guide as well as source code examples for SSP respectively eSSP only!	

5.3.2 Pin Assignments

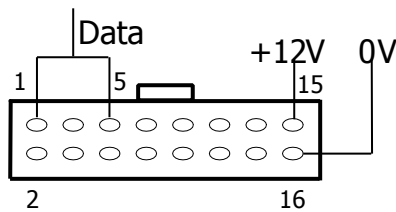

Pin	Name	Type	Description
1	Vend 1	Output	Serial Data (link to Pin 5)
2	Vend 2	Output	DA3 Data Logging
3	Vend 3	Output	Not Used
4	Vend 4	Output	Not Used
5	Inhibit 1	Input	Serial Data (link to Pin 1)
6	Inhibit 2	Input	Not Used
7	Inhibit 3	Input	Not Used
8	Inhibit 4	Input	Not Used
9	Busy	Output	Not Used
10	Escrow	Input	Not Used
11	Factory Use Only		Not Used
12	Factory Use Only		Not Used
13	Factory Use Only		Not Used
14	Factory Use Only		Do not connect
15	+ Vin	Power	+12VDC Supply
16	0V	Power	0V Supply (GND)

	Caution!
---	-----------------



+12VDC and 0V (GND) must always be connected, also when using USB connections.

5.3.3 ccTalk® DES Encryption

When using ccTalk® DES encryption, the BV20 and host machine must exchange a secret key which forms the basis of the communication encryption. This exchange is performed in a Trusted Mode maintaining security. The Trusted Mode can only be entered by a physical access to the BV20. Please refer to [Appendix XYZ](#) for details.

5.3.4 Setup Example Drawing/s

Same scheme could be used as for SSP connection:

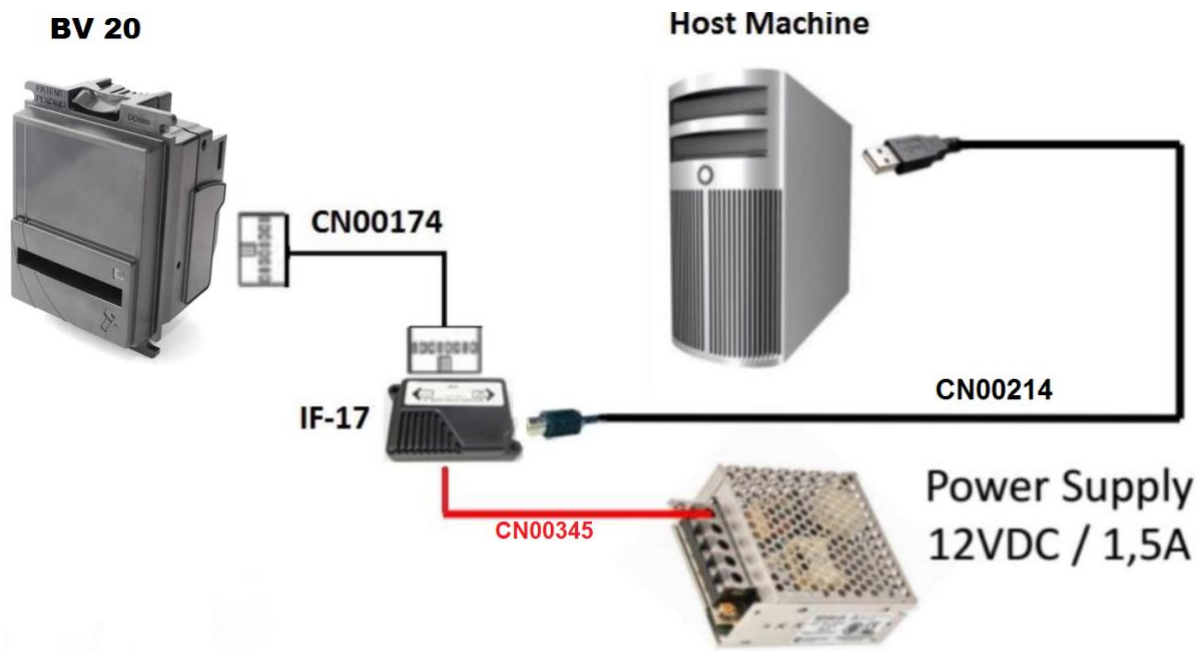



[<< Back to Contents](#)

5.4 SIO and SI2

5.4.1 General Description

SIO (Serial Input/Output) is a very basic and low level serial communication interface. Messages are not echoed back. SIO uses 300 baud whereby SI2 uses 9600 baud. Please contact support@innovative-technology.com for SIO Interface Specification or other details.

	Caution!
SIO and SI2 are outmoded and not recommended for new developments!	

	Caution!
Innovative Technology Ltd. provides full SDK packages including Interface Specification, Implementation Guide as well as source code examples for SSP respectively eSSP only!	

There are 4 different combinations of SIO available:

- SIO 300 Baud
- SIO 300 Baud (Disabled at Start up) – A software enable must be sent to enable the validator.
- SIO 9600 Baud
- SIO 9600 Baud (Disabled at Start up) – A software enable must be sent to enable the validator.



GA02118 User Manual BV20

[<< Back to Contents](#)

The Baud rate of communications can be set at either 300 or 9600 using the Validator Manager Software. The data format according to the Baud rate used is shown in below table

Baud Rate	Start Bits	Data Bits	Stop Bits
300	1	8	2
9600	1	8	1

BV20 will receive and transmit the following event codes.

Recognised Receive Codes to BV20		Transmitted Codes from BV20	
MESSAGE	DECIMAL VALUE	MESSAGE	DECIMAL VALUE
Inhibit C1	131	Note Accept on C1	1
Inhibit C2	132	Note Accept on C2	2
Inhibit C3	133	Note Accept on C3	3
Inhibit C4	134	Note Accept on C4	4
Inhibit C5	135	Note Accept on C5	5
Inhibit C6	136	Note Accept on C6	6
Inhibit C7	137	Note Accept on C7	7
Inhibit C8	138	Note Accept on C8	8
Inhibit C9	139	Note Accept on C9	9
Inhibit C10	140	Note Accept on C10	10
Inhibit C11	141	Note Accept on C11	11
Inhibit C12	142	Note Accept on C12	12
Inhibit C13	143	Note Accept on C13	13
Inhibit C14	144	Note Accept on C14	14
Inhibit C15	145	Note Accept on C15	15
Inhibit C16	146	Note Accept on C16	16
Un-inhibit C1	151	Note Not Recognised	20
Un-inhibit C2	152	Mechanism running slow	30
Un-inhibit C3	153	Strimming attempted	40
Un-inhibit C4	154	Note Rejected (fraud channel)	50
Un-inhibit C5	155	STACKER Full or Jammed	60
Un-inhibit C6	156	Abort During Escrow	70
Un-inhibit C7	157	Note may have been taken to clear jam	80
Un-inhibit C8	158	Validator Busy	120
Un-inhibit C9	159	Validator Not Busy	121
Un-inhibit C10	160	Command Error	255
Un-inhibit C11	161		
Un-inhibit C12	162		
Un-inhibit C13	163		
Un-inhibit C14	164		
Un-inhibit C15	165		
Un-inhibit C16	166		
Enable serial escrow mode	170		
Disable serial escrow mode	171		
Accept escrow	172		



[<< Back to Contents](#)

Reject escrow	173
Status	182
Enable all	184
Disable all	185
Disable escrow timeout	190
Enable escrow timeout	191

Example transactions are shown below (see table 13):

Event	Validator	Decimal Value	Host
Note entered into validator	Validator Busy	120→	
Note accepted channel 2	Validator Ready	121→	
	Accept on channel 2	2→	
Note entered into validator	Validator Busy	120→	
Note not recognised	Validator Ready	121→	
	Note not recognised	20→	
Validator has returned note	Validator Ready	121→	
Software Inhibit Channel 4	Inhibit C4	←134	Inhibit C4
	Channel 4 inhibited	134→	
Software Enable Channel 4	Uninhibit C4	←154	Uninhibit C4
	Channel 4 inhibited	154→	
Status Report		←182	Status Request
	Status Requested	182→	
3 byte status message	Inhibit status Channels 1-8	Byte 1→	
	Inhibit status Channels 9-16	Byte 2→	
	Escrow On (=1) / Off (=0)	Byte 3→	
Turn on Escrow Mode		← 170	Enable Escrow Mode
	Escrow Mode Enabled	170→	
Note accept in Escrow Mode			
Note entered into validator	Validator Busy	120→	
Note Accepted Channel 2	Validator Ready	121→	
	Accept on Channel 2	2→	
		←172	Accept Note in Escrow
	Accept Escrow	172→	
	Accept on Channel 2	2→	



[<< Back to Contents](#)

5.4.2 Pinout

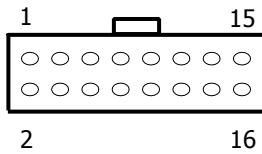

Pin	Name	Type	Description
1	Vend 1	Output	Serial Data Out (Tx)
2	Vend 2	Output	Not Used
3	Vend 3	Output	Not Used
4	Vend 4	Output	Not Used
5	Inhibit 1	Input	Serial Data In (Rx)
6	Inhibit 2	Input	Not Used
7	Inhibit 3	Input	Not Used
8	Inhibit 4	Input	Not Used
9	Busy	Output	Not Used
10	Escrow	Input	Not Used
11	Factory Use Only		Do not connect
12	Factory Use Only		Do not connect
13	Factory Use Only		Do not connect
14	Factory Use Only		Do not connect
15	+ Vin	Power	+12VDC Supply
16	0V	Power	0V Supply (GND)



5.5 MDB

5.5.1 General Description

MDB (Multi-Drop Bus) is used in the vending industry and is now an open standard in the NAMA (National Automatic Merchandising Association) so that all vending and peripheral equipment communicates identically. MDB uses a master-slave model where the VMC (Vending Mechanism Controller) is the master that can communicate with up to 32 slaves (e.g. banknote validator or coin acceptor).

Note:

- Please refer to the Multi-Drop Bus specification for the suggested current drive circuits available.
- The BV20 supports the MDB Protocol version 1, level 1.
- For detailed information and full protocol specification refer to www.vending.org
- MDB address: - 0x30

The BV20 Bank Note Validators have a unique address – 00110XXX binary (30H). The VMC polls the bus to detect presence of the BV20 Validator or get information on the current status of the validator.

The validators will respond when asked for activity with an acknowledgment, a negative acknowledgment or a specific reply, depending on its current status. Bus crashes are avoided as the validators respond to being polled only by the VMC.

The international country code must be set for the country in which the validators will be operating. This is either the international telephone code for that country, or the country code taken from ISO4217. The code is represented as two bytes. The initial digit signifies the source of the code. 0 signifies the telephone code is used, 1 signifies ISO4217 has been used. For the USA the country code is 00 01, or 18 40. For Great Britain the code is 00 44, or 18 26.

The scaling factor must also be specified for each validator. All accepted note values must be evenly divisible by this number.

- This number would be set to 100 (Hex 64) for the Euro or Great Britain.
- The number would be set to 1000 (Hex 03E8) for Columbia.
- The number of decimal places must also be programmed for each validator
- The number would be set to 2 for Euro or USA
- The number would be set to 3 for Columbia

Adopting the numbers above:

- £5 would be displayed as 5.00
- £10 would be displayed as 10.00



[<< Back to Contents](#)

- \$1 would be displayed as 1.00
- 1K Columbia would be displayed as 1.000

Please contact support@innovative-technology.com for further information.

	Caution!
Innovative Technology Ltd. provides full SDK packages including Interface Specification, Implementation Guide as well as source code examples for SSP respectively eSSP only!	

5.5.2 Pinout

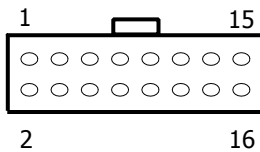

Pin	Name	Type	Description
1	Vend 1	Output	Serial Data Out (Tx)
2	Vend 2	Output	Not Used
3	Vend 3	Output	Not Used
4	Vend 4	Output	Not Used
5	Inhibit 1	Input	Serial Data In (Rx)
6	Inhibit 2	Input	Not Used
7	Inhibit 3	Input	Not Used
8	Inhibit 4	Input	Not Used
9	Busy	Output	Not Used
10	Escrow	Input	Not Used
11	Factory Use Only		Do not connect
12	Factory Use Only		Do not connect
13	Factory Use Only		Do not connect
14	Factory Use Only		Do not connect
15	+ Vin	Power	+12VDC Supply
16	0V	Power	0V Supply (GND)



[<< Back to Contents](#)

5.5.3 IF5 Interface

To use the MDB mode, an [IF5](#) interface box can be used.



5.5.4 MDB PSU

	Caution!
An IF5 cannot be used with BV20110VPSU	

BV20 can be used with [MDB PSU](#), which allows to use validator directly with MDB applications:



[<< Back to Contents](#)

5.5.5 Setup Example Drawing/s

For MDB PSU mounting:

1. Clip MDB PSU onto BV20's External Hardware Clip

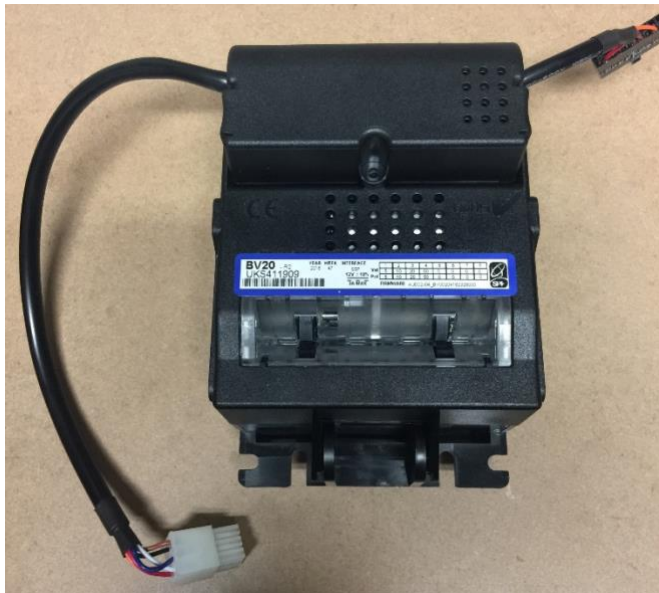
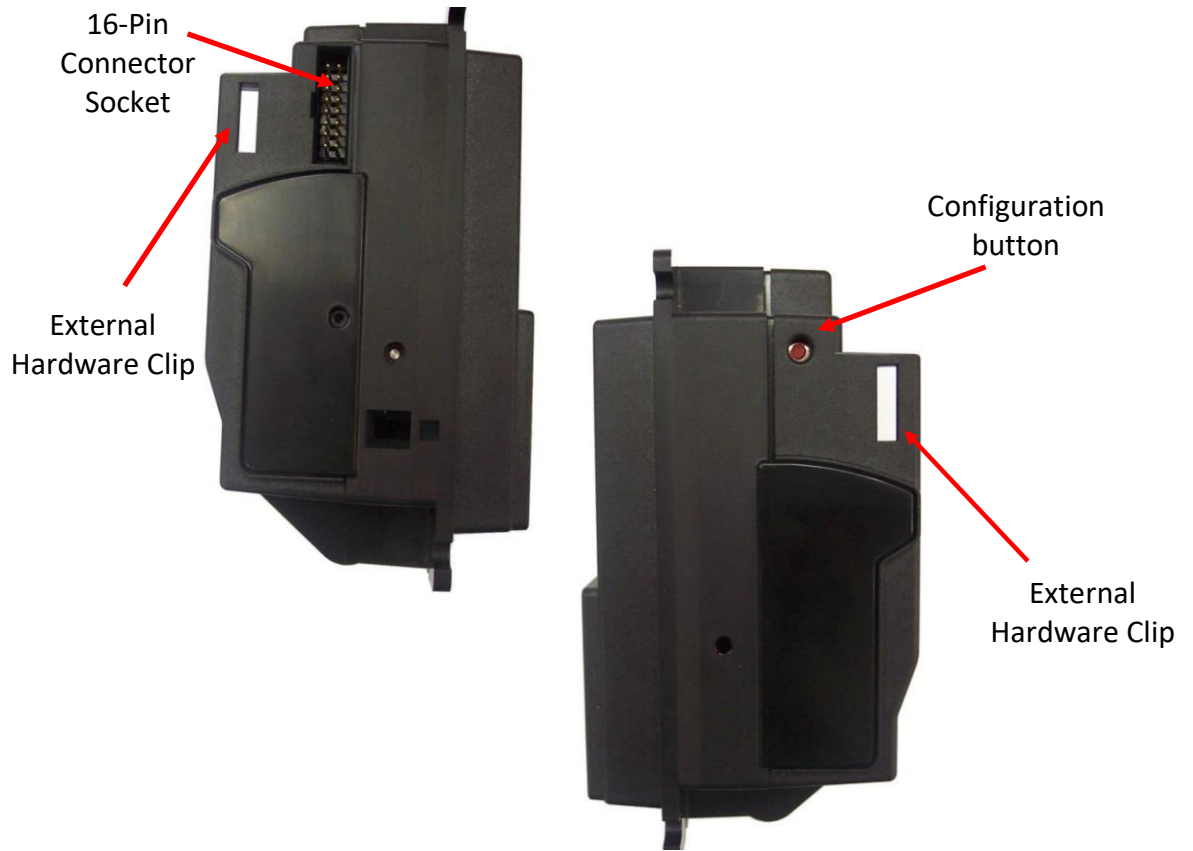

[<< Back to Contents](#)

2. Plug MDB PSU 20 pin connector into BV20's 16 pin connector socket:

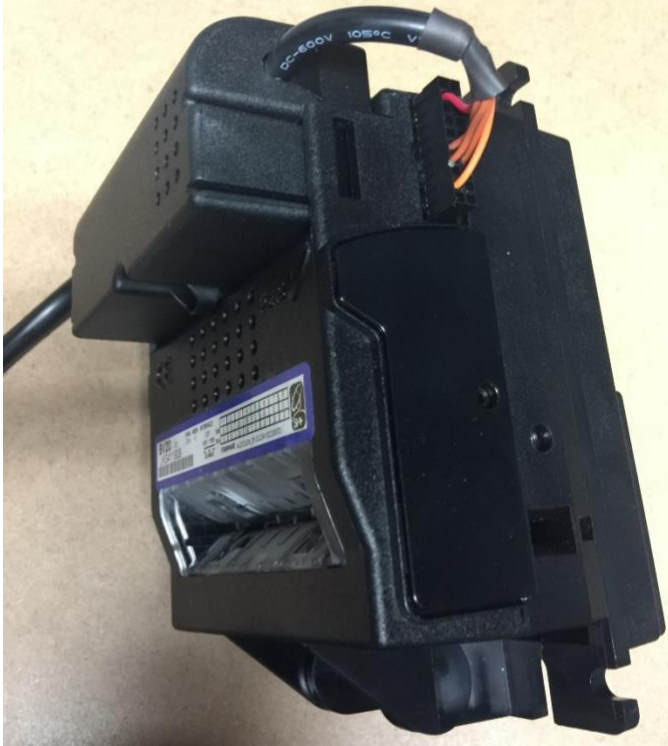

BV20 MDB PSU now installed.

5.6 Parallel

5.6.1 General Description

Parallel is a 4-way output interface. The first 4 channels have their own individual output which means that only a maximum of 4 channels can be used. If a note is recognised the relevant Vend line is set to low for a period of $100 \pm 3\text{ms}$. Pulses outside these limits should be rejected as a precaution against false triggering.

	Caution!
Parallel is an unsecure interface and should not be used for new developments!	

5.6.2 Pinout

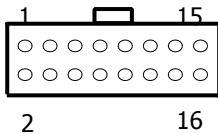

Pin	Name	Type	Description
1	Vend 1	Output	Credit Output Channel 1
2	Vend 2	Output	Credit Output Channel 2
3	Vend 3	Output	Credit Output Channel 3
4	Vend 4	Output	Credit Output Channel 4
5	Inhibit 1	Input	Inhibit Input Channel 1 by holding HIGH, hold LOW to enable
6	Inhibit 2	Input	Inhibit Input Channel 2 by holding HIGH, hold LOW to enable
7	Inhibit 3	Input	Inhibit Input Channel 3 by holding HIGH, hold LOW to enable
8	Inhibit 4	Input	Inhibit Input Channel 4 by holding HIGH, hold LOW to enable
9	Busy	Output	Output Busy Signal. Active LOW when BV20 is in transporting, reading or stacking a note
10	Escrow	Input	Input Escrow Control. Enable escrow function by holding LOW
11	Factory Use Only		Do not connect
12	Factory Use Only		Do not connect
13	Factory Use Only		Do not connect
14	Factory Use Only		Do not connect
15	+ Vin	Power	+12VDC Supply
16	0V	Power	0V Supply (GND)

5.6.3 Inhibit Control

The Inhibits can be used to either enable or disable the acceptance of those banknotes programmed on channels 1, 2, 3 and 4. The Inhibits are internally held high and must be set to low (GND) to enable banknote acceptance. If no Inhibit is set to low (GND) the Master Inhibit is set and the BV20 is disabled.



[<< Back to Contents](#)

5.6.4 Escrow Control

The BV20 has a single note escrow facility. This allows the BV20 to hold onto the note once validated, and then only stack the note into a cashbox when the host machine confirms that the Vend operation has been completed. Hold pin 10 LOW to enable the single note escrow function. If the host machine aborts the transaction by setting the corresponding inhibit input HIGH, the note is returned immediately.

The host machine can force the return of the 30 second time-out. Setting HIGH on all the inhibits causes all notes rejected. In the event of a note being forcibly removed from the BV20 bezel during the 30-second interval, the BV20 will go out of service for 45 seconds.

Please refer to [11.8](#) for timing diagram and further details.

5.6.5 Busy Control

This is a general-purpose busy signal. It is active low (pin 9) while the BV20 is in operation.

5.6.6 Low Power Mode

The Low Power Mode can be used to reduce the power consumption of the BV20 when idle. When the Low Power Mode option is set, the BV20 goes into the Low Power Mode after about 6 seconds after the BV20 is powered up and remains in this state until a note is entered. Following a note insertion, the BV20 returns to Low Power Mode approximately 1 second after a credit is given or note is rejected.

Please refer to [11.9](#) for timing diagram and further details.

	Caution!
In Low Power Mode the front sensor is checked every second which can lead to a delay in accepting the note when it is presented!	

	Caution!
Configuration button functions are only available during power up before the BV20 goes into Low Power Mode!	

5.6.7 IF10 Interface

The IF10 is an interface that allows serial SSP to be used in machines without the need of updating the machine software. The IF10 is connected between the BV20 and the host machine. The IF10 communicates with the BV20 in serial SSP which gives more security along the length of the cable. The IF10 should be mounted close to the host machine control board where the IF10 converts to the parallel connection.





5.7 Binary

5.7.1 General Description

In the event that the machine needs more than 4 denominations to be recognised but the host machine cannot take advantage of the serial communication method then the BV20 can be set to give a binary pattern output on the four parallel output pins. If the BV20 is set to Binary it will issue the vend signals as a binary pattern on the parallel outputs for 100 ± 3 ms. In this way a maximum of 15 different notes can be accepted and 4 notes individually inhibited.

The four channels have their own individual outputs. If a note is recognised the binary representation of the channel number will be pulled low for 100 ± 3 ms. Pulses outside these limits will be rejected as a precaution against false triggering due to noise.

For example, if a note programmed on channel 3 is credited vend 1 ($2^0 = 1$ decimal) and vend 2 ($2^1 = 2$ decimal) will be active low for 100 ± 3 ms.

	Caution!
Binary is an unsecure interface and should not be used for new developments!	

5.7.2 Pinout

Pin	Name	Type	Description
1	Vend 1	Output	Credit Output binary $2^0 = 1$ decimal
2	Vend 2	Output	Credit Output binary $2^1 = 2$ decimal
3	Vend 3	Output	Credit Output binary $2^2 = 4$ decimal
4	Vend 4	Output	Credit Output binary $2^3 = 8$ decimal
5	Inhibit 1	Input	Inhibit Input Channel 1
6	Inhibit 2	Input	Inhibit Input Channel 2
7	Inhibit 3	Input	Inhibit Input Channel 3
8	Inhibit 4	Input	Inhibit Input Channel 4
9	Busy	Output	Output Busy Signal
10	Escrow	Input	Input Escrow Control
11	USB +	Data	Not Used
12	USB -	Data	Not Used

[<< Back to Contents](#)

13	USB Vcc	Power	Not Used
14	Factory Use Only		Do not connect
15	+ Vin	Power	+12VDC Supply
16	0V	Power	0V Supply (GND)

5.7.3 Inhibit Control

The Inhibits can be used to either enable or disable the acceptance of those banknotes programmed on channels 1, 2, 3 and 4. The Inhibits are internally held high and must be set to low (GND) to enable banknote acceptance. If no Inhibit is set to low (GND) the Master Inhibit is set and the BV20 is disabled.

5.7.4 Escrow Control

The BV20 has a single note escrow facility. This allows the BV20 to hold onto the note once validated, and then only stack the note into a cashbox when the host machine confirms that the Vend operation has been completed. Please refer to [11.8](#) for further details.

5.7.5 Busy Control

5.7.6 Low Power Mode

The Low Power Mode can be used to reduce the power consumption of the BV20 when idle. When the Low Power Mode option is set, the BV20 goes into the Low Power Mode after about 6 seconds after the BV20 is powered up and remains in this state until a note is entered. Following a note insertion, the BV20 returns to Low Power Mode approximately 1 second after a credit is given or note is rejected. Please refer to [11.9](#) for timing diagram and further details.

	Caution!
In Low Power Mode the front sensor is checked every second which can lead to a delay in accepting the note when it is presented!	

	Caution!
Configuration button functions are only available during power up before the [Product Name] goes into Low Power Mode!	

5.7.7 IF9 Interface

The [IF9](#) is an interface that allows serial SSP to be used in machines without the need of updating the machine software. The IF9 is connected between the BV20 and



[<< Back to Contents](#)

the host machine. The IF9 communicates with the BV20 in serial SSP which gives more security along the length of the cable. The IF9 should be mounted close to the host machine control board where the IF9 converts to the binary connection.

5.8 Pulse

5.8.1 General Description

Pulse can be used for the acceptance of up to 16 channels. When a note is recognised vend 1 (pin 1) will pulse a pre-set number of times. The amount of pulses as well as the high/low pulse ratio is configurable. For programming and configuration please refer to [Section 4](#) of this User Manual.

	Caution!
Pulse is an unsecure interface and should not be used for new developments!	

5.8.2 Pinout

Pin	Name	Type	Description
1	Vend 1	Output	Credit Output Pulse Stream
2	Vend 2	Output	Not Used
3	Vend 3	Output	Not Used
4	Vend 4	Output	Not Used
5	Inhibit 1	Input	Inhibit Input Channel 1
6	Inhibit 2	Input	Inhibit Input Channel 2
7	Inhibit 3	Input	Inhibit Input Channel 3
8	Inhibit 4	Input	Inhibit Input Channel 4
9	Busy	Output	Output Busy Signal
10	Escrow	Input	Input Escrow Control
11	USB +	Data	Not Used
12	USB -	Data	Not Used
13	USB Vcc	Power	Not Used
14	Factory Use Only		Do not connect
15	+ Vin	Power	+12VDC Supply
16	0V	Power	0V Supply (GND)

5.8.3 Inhibit Control

The Inhibits can be used to either enable or disable the acceptance of those banknotes programmed on channels 1, 2, 3 and 4. The Inhibits are internally held high and must be set to low (GND) to enable banknote acceptance. If no Inhibit is set to low (GND) the Master Inhibit is set and the [Product Name] is disabled.



5.8.4 Escrow Control

The [Product Name] has a single note escrow facility. This allows the [Product Name] to hold onto the note once validated, and then only stack the note into a cashbox when the host machine confirms that the Vend operation has been completed. Please refer to [11.8](#) for further details.

5.8.5 Busy Control

5.8.6 Low Power Mode

The Low Power Mode can be used to reduce the power consumption of the BV20 when idle. When the Low Power Mode option is set, the BV20 goes into the Low Power Mode after about 6 seconds after the BV20 is powered up and remains in this state until a note is entered. Following a note insertion, the BV20 returns to Low Power Mode approximately 1 second after a credit is given or note is rejected. Please refer to [11.9](#) for timing diagram and further details.

	Caution!
In Low Power Mode the front sensor is checked every second which can lead to a delay in accepting the note when it is presented!	

	Caution!
Configuration button functions are only available during power up before the [Product Name] goes into Low Power Mode!	

5.8.7 Credit Hold Function

If this function is enabled the BV20 will take the notes as normal but then wait until the escrow line is toggled low/high before it will then give out the pulses per denomination as set. After the pulses have been given, the BV20 will wait for another low/high toggle until the full value of credit pulses are given.

For example, with a setting of 2 pulses per dollar, a five dollar bill will give 2 pulses 5 times.

A Typical use of this option would be for a Pool table with a game price of \$1. You could insert a \$5 note and press a button that toggles the escrow line and releases the pool balls, this would then allow you to play the first game. The Validator holds onto the remaining credits until the game has finished and the button is pressed again allowing the next game to begin, this continues until all the credits have been used.



[<< Back to Contents](#)

The busy line remains low throughout the whole process and the BV20 remains inhibited until all pulses are given.

5.8.8 IF15 Interface

The IF15 is an interface that allows serial SSP to be used in machines without the need of updating the machine software. The IF15 is connected between the BV20 and the host machine. The IF15 communicates with the BV20 in serial SSP which gives more security along the length of the cable. The IF15 should be mounted close to the host machine control board where the IF15 converts to the pulse connection.



6 ROUTINE MAINTENANCE

6.1 Introduction

The BV20 has been designed to minimise any performance variation over time. Much of this is achieved by careful hardware and software design. However, depending upon the environment the BV20 may at some time require cleaning, belt changing or note path clearing.

6.2 Recommended Cleaning Intervals

Innovative Technology Ltd recommends to clean the optical lenses every month or as required. Dirt, dust or other residue leads to bad note acceptance and other performance degradation. Please refer to [8.8](#) for comprehensive cleaning instructions.



7 FIRST LEVEL SUPPORT

7.1 Bezel LED Flash Codes

The Bezel LED's are used to indicate a variety of status signals as described below.

Number of long flashes	Number of short flashes			
	1	2	3	4
1		Note Path Jam	Unit not initialized*	Sensor covered
2				
3	Firmware Checksum	Interface Checksum	EEPROM Checksum	Dataset Checksum
4	PSU is too low	PSU is too high		

*- refer to section [8.4](#) for unit initializing.

7.2 Configuration Button Functions

The BV20 has [Configuration Button](#), which allows to perform several functions:

Configuration Button	Power Status	Function
Press and Hold (>2 secs)	Powered ON	Sets BV20 to Programming Mode (SSP protocol)
Press Once (<1 sec)	Powered ON	Enables Configuration Card Programming Mode
Press Twice (within half a second)	Powered ON	Current Setting Indicator
Press and hold as power is applied	Powered OFF/ON	Resets ccTalk key to Default setting

7.3 Checking Power and Communication Connections

1. Connect BV20 via TTL-USB adapters, either IF-17 or DA2 should be used. ITL provides principal electrical scheme of IF-17 adapter, please contact support@innovative-technology.co.uk for details.
2. Power supply parameters details are described in Section [10.4](#). See also Bezel LED flash codes to identify any validator's errors in section [7.1](#).



[<< Back to Contents](#)

7.4 Program Check Procedure

To check settings on a programmed unit:

1. Power on unit.
2. Click red configuration button on unit twice.
3. Monitor bezel led and check flash codes:

	Flash count	Pulse High	Pulse Low	Pulse per dollar	High speed	Disabled	ccTalk plain	ccTalk 8 bit	low power	binary	Credit Hold	No escrow/out
SSP	1											
Pulse	2	ms/10	ms/10	value							3 flash	
MDB	3											
IF 30	4											
IF 31	5											
ccTalk	6						1 flash	2 flashes				3 flashes
SIO	7				1 flash	2 flashes						3 flashes
Parallel	8									1 flash		2 flashes
SP4	9	ms/10	ms/10	value							3 flash	
NIS	10											
IF 32	11				1 flash							
spare	12											
spare	13											
spare	14											

For example:

A Pulse interface with 50ms high, 100ms low, 2 pulse per dollar will flash 2,5,10,2

A SSP interface will only ever flash once

A ccTalk interface with 16 bit checksum, no encryption will flash 6,1

A ccTalk interface with 8 bit checksum, no encryption will flash 6,1,2

A Binary interface will flash 8,1



8 SECOND LEVEL SUPPORT

8.1 Clearing a Jam

1. Press the Lozenge Release Catch and softly pull open bezel



2. Carefully pull the banknote from behind BV20 until it has come from validator head.





3. Inspect the visible parts of validator of any banknote remains. Then close bezel.
4. Power off then on validator to return to work.

Refer to [7.1](#) if validator flashes after procedure with any flash count.

[<< Back to Contents](#)

8.2 Cleaning the BV20

	Caution!
Do not use solvent based cleaners such as alcohol, petrol, methylated spirits, white spirit or PCB cleaner. This will result in permanent damage to the [Product Name], only use a mild detergent.	

	Caution!
Dirt, dust or other residue causes bad note acceptance rates and other performance degradation. The recommended cleaning interval is once a month!	

1. Unclip Bezel from BV20 by pressing Lozenge Release Catch and pulling bezel:



2. Wipe dirt and debris away from wheels with a piece of cloth:



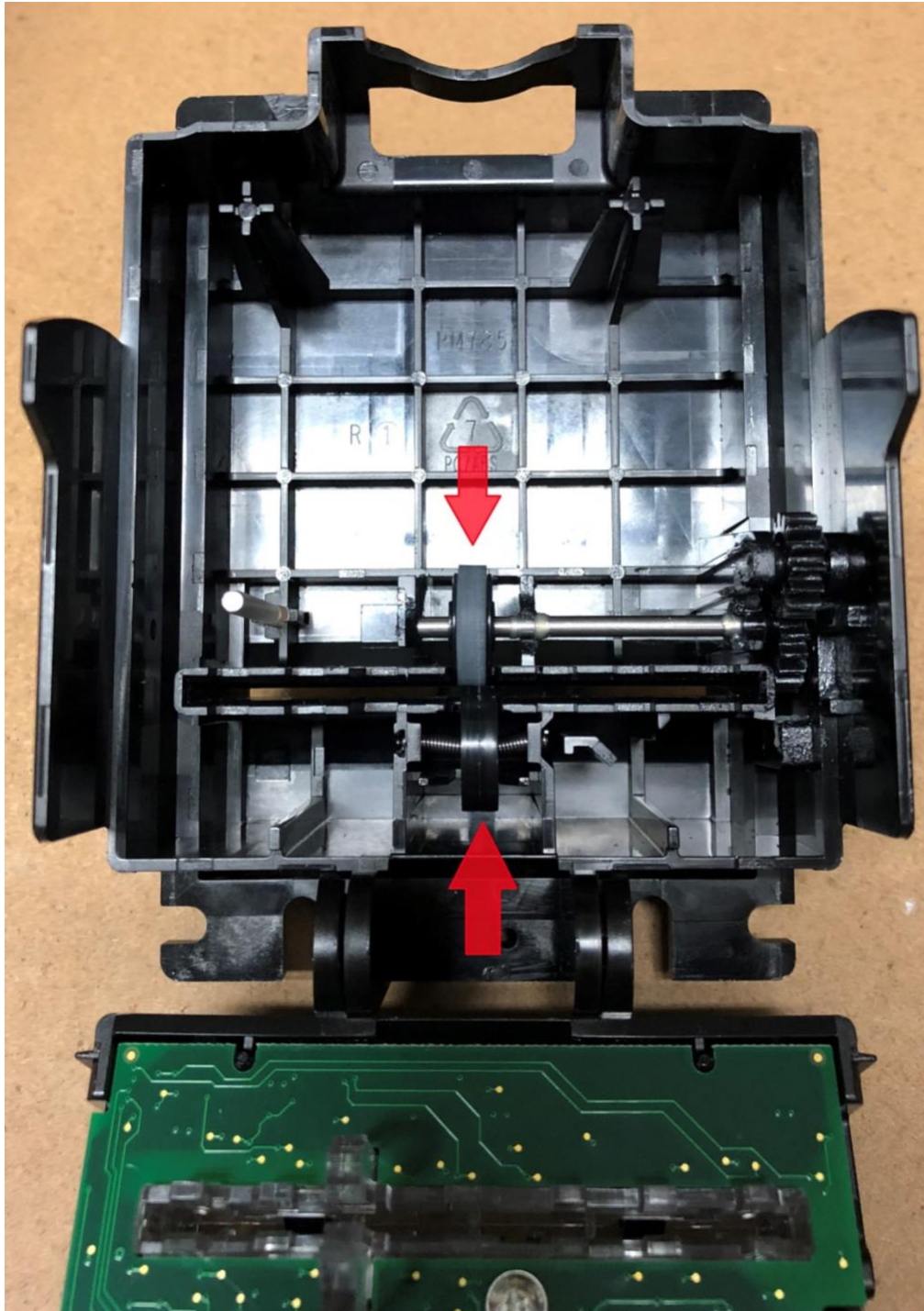

8.3 Clearing a Checksum Error

According [Flash Codes Table](#), some LED's flashing may indicate CHECKSUM errors. It may happen when, during comparing, validator's checksum does not match with original file's one after some manipulations (updating, repairing, etc.).

In this case, reprogram validator using Validator Manager program as described in [4.4.1.5](#) section. Test validator with several different banknotes after error is removed.

If error persists, use another Dataset file for downloading to localize problem reason. If error is not disappearing, use EEPROM downloader software.

Please, contact support@innovative-technology.com for details.

[<< Back to Contents](#)

8.4 Re-initialisation of the sensors

For this procedure, please use ITL Diagnostic Tools (v.2.0.2 and higher) and Green calibration paper [LB00160](#).

1. Connect validator using IF-17/DA2 adapter only, open Diagnostic Tools program and choose active com-port:



2. Then click "Initialise" tab:



3. Validator will start initialization procedure.
Once the motor run continuously, insert green calibration paper



GA02118 User Manual BV20

[<< Back to Contents](#)

Innovative Technology
INTELLIGENCE IN VALIDATION

Help About

Start Diagnostics Controls **Initialise** Options

Sensor	Calibration Status	Gain 1	Gain 2
X21 Red Through	Not calibrated	0	0
X21 IR Through	Not calibrated	0	0
X22 Red Through	Not calibrated	0	0
X22 IR Through	Not calibrated	0	0
X23 Red Through	Not calibrated	0	0
X23 IR Through	Not calibrated	0	0
X24 Red Through	Not calibrated	0	0
X24 IR Through	Not calibrated	0	0
Card Read 21			
Card Read 22			
Front 21			
Strim 21	Calibration complete	38	2
Start 21	Calibration complete	27	3
Start 22	Calibration complete	31	4
Width 1	Not calibrated	0	0
Width 2	Not calibrated	0	0
Width 3	Not calibrated	0	0
Width 4	Not calibrated	0	0

Initialisation complete

Initialisation completed successfully. Click ok to check results

OK

Initialise Sensors



[<< Back to Contents](#)

4. Initialization process now complete:

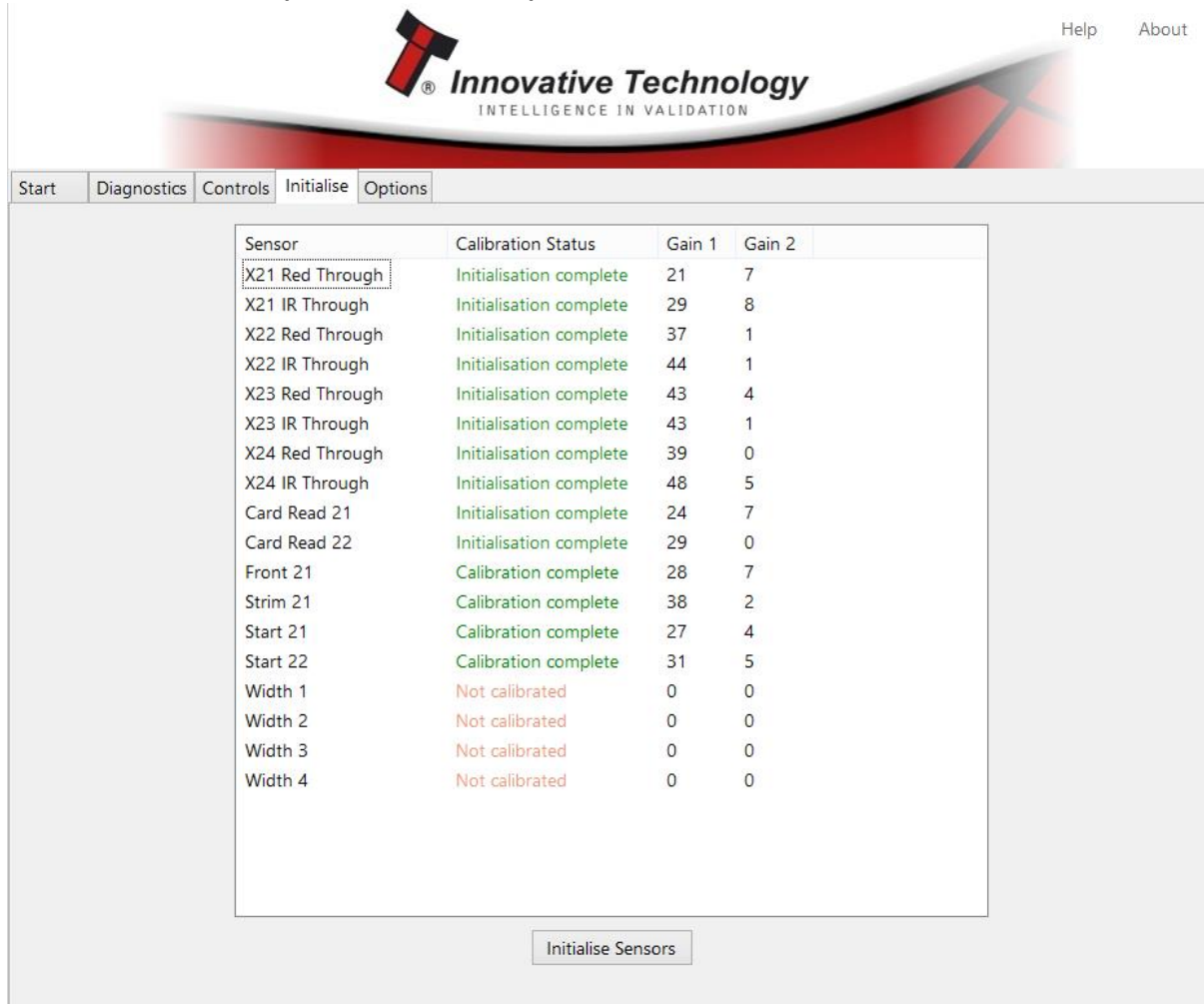

The screenshot shows the software interface for Innovative Technology. The top navigation bar includes 'Start', 'Diagnostics', 'Controls', 'Initialise', and 'Options'. The 'Initialise' tab is active, displaying a table of sensor calibration status. The table has four columns: 'Sensor', 'Calibration Status', 'Gain 1', and 'Gain 2'. The 'Calibration Status' column shows 'Initialisation complete' in green for most sensors and 'Not calibrated' in red for the 'Width' sensors. Below the table is an 'Initialise Sensors' button.

Sensor	Calibration Status	Gain 1	Gain 2
X21 Red Through	Initialisation complete	21	7
X21 IR Through	Initialisation complete	29	8
X22 Red Through	Initialisation complete	37	1
X22 IR Through	Initialisation complete	44	1
X23 Red Through	Initialisation complete	43	4
X23 IR Through	Initialisation complete	43	1
X24 Red Through	Initialisation complete	39	0
X24 IR Through	Initialisation complete	48	5
Card Read 21	Initialisation complete	24	7
Card Read 22	Initialisation complete	29	0
Front 21	Calibration complete	28	7
Strim 21	Calibration complete	38	2
Start 21	Calibration complete	27	4
Start 22	Calibration complete	31	5
Width 1	Not calibrated	0	0
Width 2	Not calibrated	0	0
Width 3	Not calibrated	0	0
Width 4	Not calibrated	0	0

If some of statuses are red, try to repeat initialization procedure.

Having same result, probably validator require repairing/some elements replacing.

For initialization file receiving, please, contact support@innovative-technology.co.uk.



9 TECHNICAL DATA

9.1 Dimensions

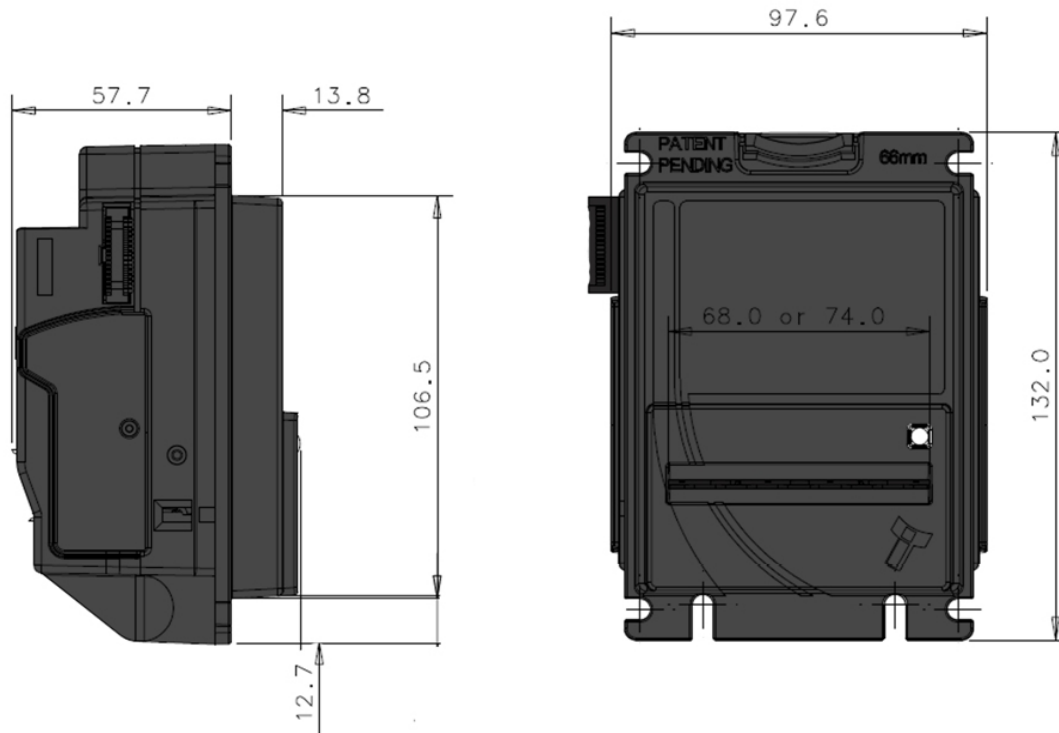

9.2 Weight

- Validator = 0.3 kg

9.3 Environmental Requirements

Environment	Minimum	Maximum
Temperature	+3°C	+50°C
Humidity	5%	95% Non-condensing

9.4 Power Requirements

9.4.1 Supply Voltages

Supply Voltage	Minimum	Nominal	Maximum
Supply Voltage (V DC)	+ 10.8 V DC	+ 12 V DC	+ 14.2 V DC
Supply Ripple Voltage	0 V	0 V	0.25 V @ 100 Hz

9.4.2 Supply Currents

Supply Current	Maximum
Standby	0.15 A
Running	0.54 A
Peak	1.50 A

[<< Back to Contents](#)

9.4.3 Power Supply Guidance

The BV20 requires a stable 12V DC / 1.7A power supply. Please check the power requirements of your host machine and other peripherals to dimension a suitable power environment for your machine setup.

TDK Lambda manufactures suitable power supplies. Please see table below for further details.

Power Supply Unit	Specification	RS Stock Code	Farnell Stock Code
TDK Lambda SWS50-12	+12 V DC / 4.3 A	466-5869	1184645

- Power supply is to be earthed

9.5 Interface Logic Levels

Interface Logic Levels	Logic Low	Logic High
Inputs	0V to +0.5V	+3.7V to +12V
Outputs with 2K2Ω pull-up resistor	+0.6V	Pull-up voltage of host interface
Maximum Current Sink	50mA per Output	

9.6 Reliability Data

- MCBF: 100,000

9.7 Media Requirements

- Notes length: 150 – 180mm
- Notes width: 48 – 72mm
- Polymer and windowed notes



10 COMPLIANCES AND APPROVALS

10.1 EC Declaration of Conformity

- RoHS
- EN Directives
- UL
- REACH
- WEEE
- Central Bank Approvals



11 APPENDIX

11.1 Cable Drawings

[CN00174](#) Ribbon Cable (validator to IF-17):

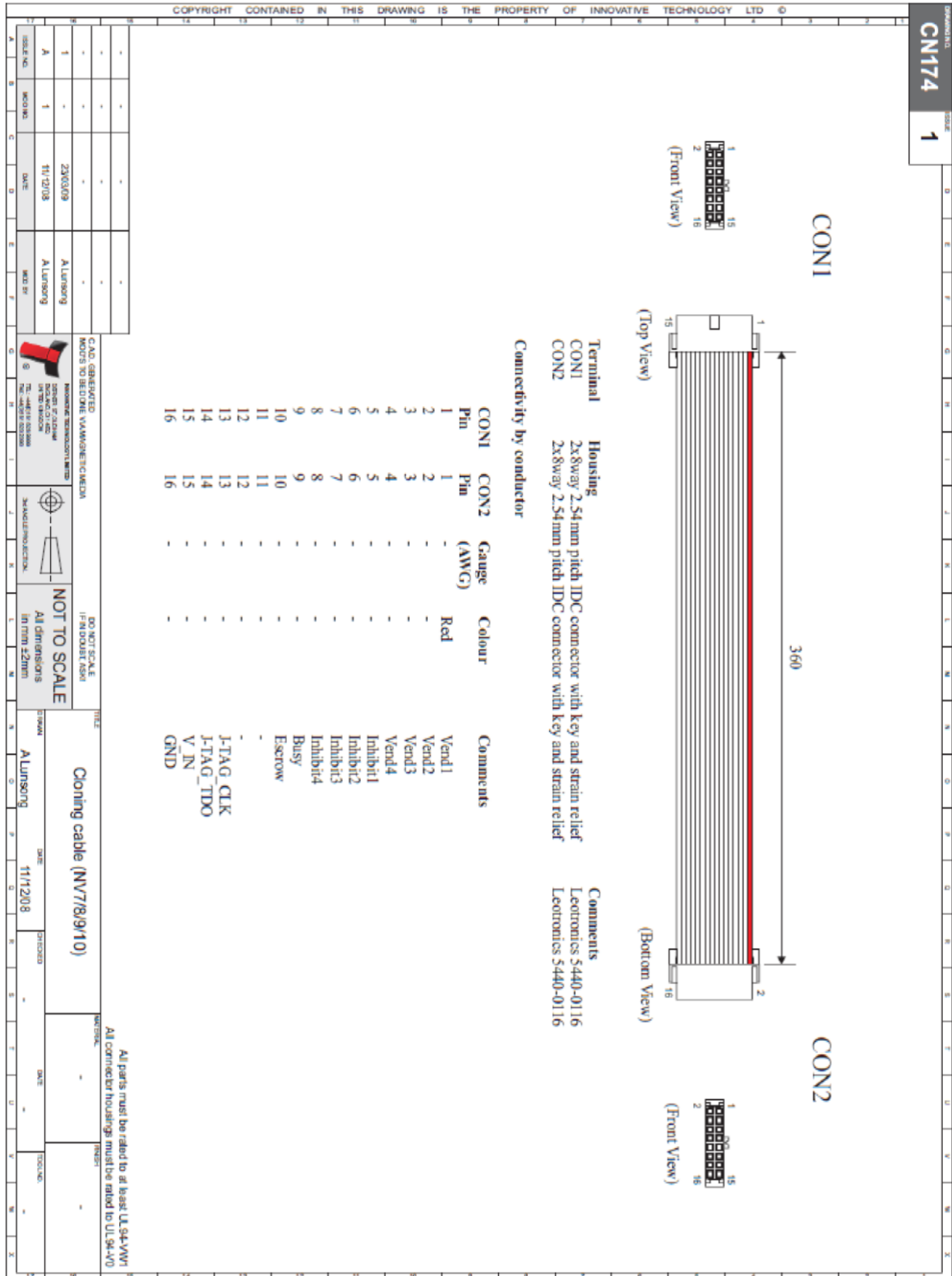

300mm or longer



GA02118 User Manual BV20

[<< Back to Contents](#)

IF17/IF18/DA3 Power Cable:

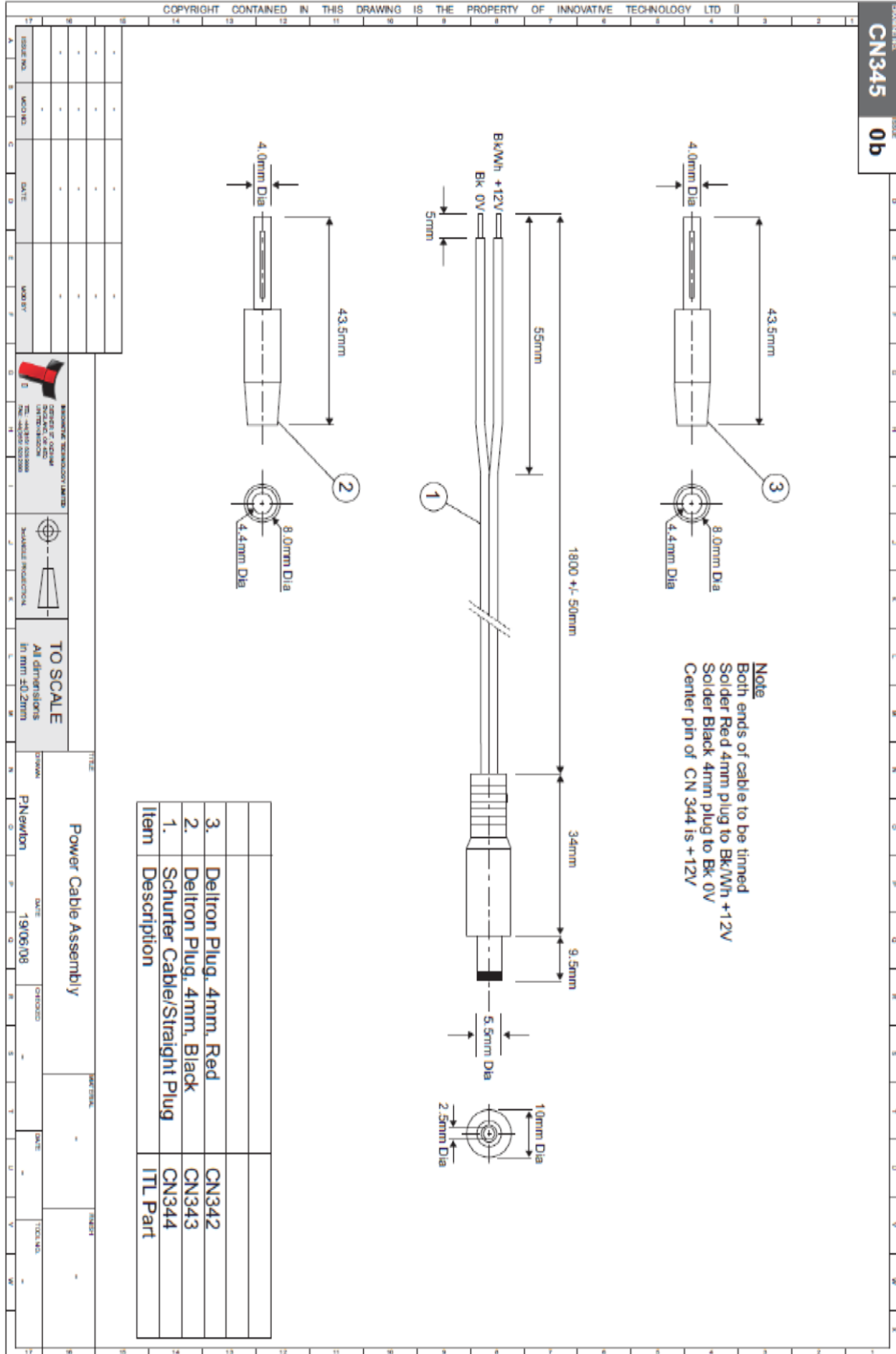

[<< Back to Contents](#)

CN00214 USB A-B Cable (host to IF-17):

ITL Part Number	Description	Details
CN214	USB Cable	USB 2.0 Compliant Type A to Type B cable

11.2 Connector Specifications

Type	Vendor	Part Number	Pins	Pitch	Polarising
Housing	Leotronics	2652-2161	2x8	2.54mm	With Key
Crimp	Leotronics	2653-2000			Female
Housing	Molex	90142-0016	2x8	2.54mm	With Key
Crimp	Molex	90119-2121			Female

11.3 Switching to Programming Mode (SSP)

Press and Hold the Configuration Button for at least 2 seconds whilst the BV20 is powered up. The Bezel LED will flash rapidly to indicate that SSP is being loaded. Once this process has finished the BV20 will reset. The BV20 will now be in Programming Mode (SSP) and allow connection to a PC via a DA1 or DA2 adapter or connection to a DA3.

11.4 Free Fall Cashbox Advice

When installing BV20, adequate space in width and length must be allowed for received notes to be free falling behind BV20. Notes not allowed free falling will cause validator to malfunction.

11.5 ccTalk DES Encryption – Trusted Mode

The [DES](#) compatibility can be toggled on/off using Validator Manager version 3.3.12 or later. On the menu select Tools - Set Validator Options. On the General Options tab, the "cct DES encrypted" checkbox will be available when ccTalk® (CCT) interface is set. Click Apply Changes once the validator is configured as required.

In DES Trusted mode host requests the security keys of peripheral. Once obtained, the keys need not be transferred again until the peripheral is replaced. For key exchanging, please power on unit in ccTalk protocol and wait for a several seconds for key exchanging.

Use configuration button for rollback any previously set ccTalk key to original (see Configuration Button options, section [7.2](#)).



11.6 Escrow Control

The BV20 has a single note escrow facility. This allows the BV20 to hold onto the note once validated, and then only stack the note into a cashbox when the host machine confirms that the Vend operation has been completed. If no confirmation of the Vend is received, then the note will be returned to the user after 30 seconds. If the host machine itself aborts the transaction by setting the corresponding inhibit input high, the note is returned immediately. The sequence of operation is as follows:

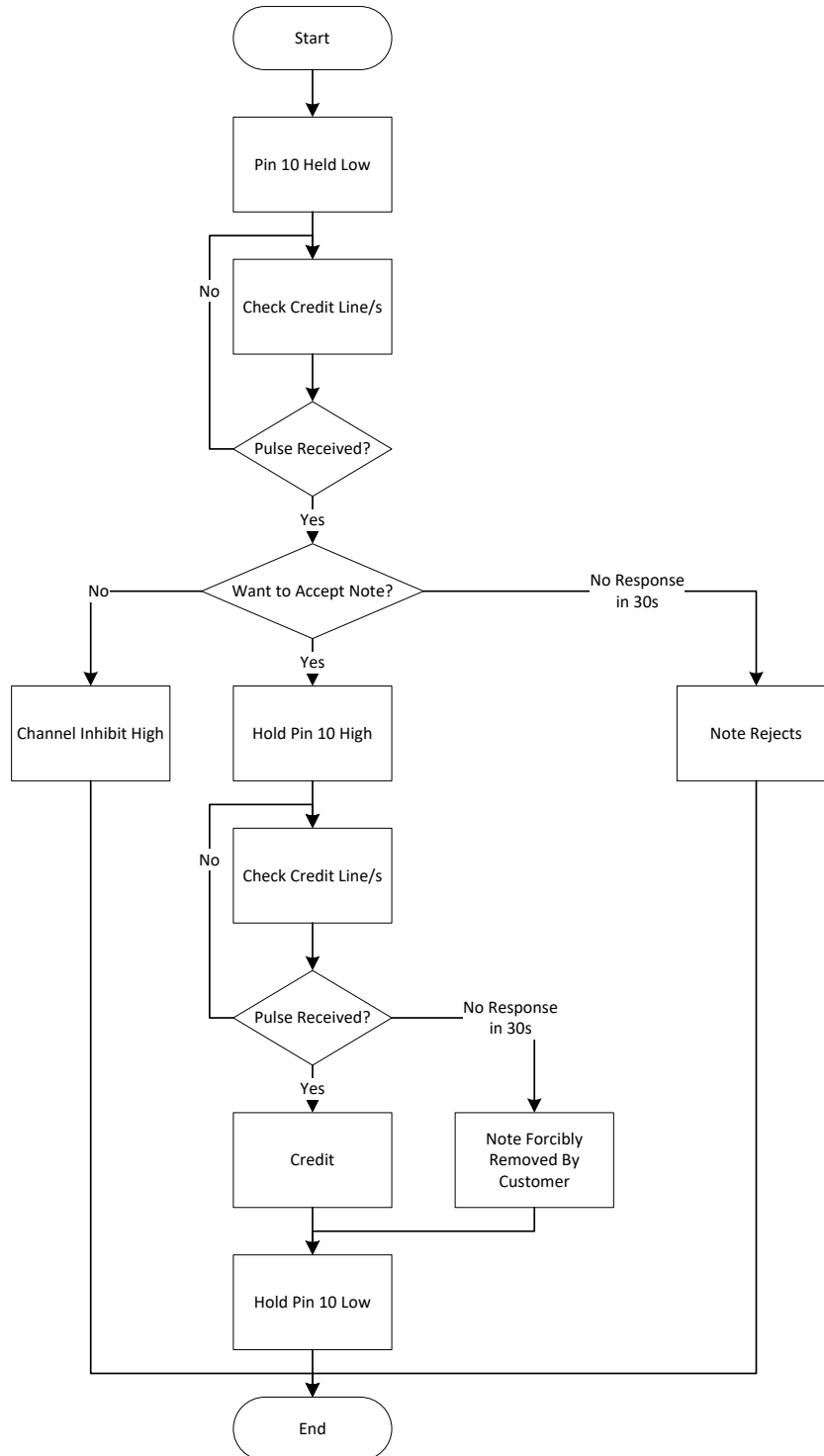

	Caution!
Only book the credit on the second Vend pulse!	

11.6.1 Escrow Timing Diagram

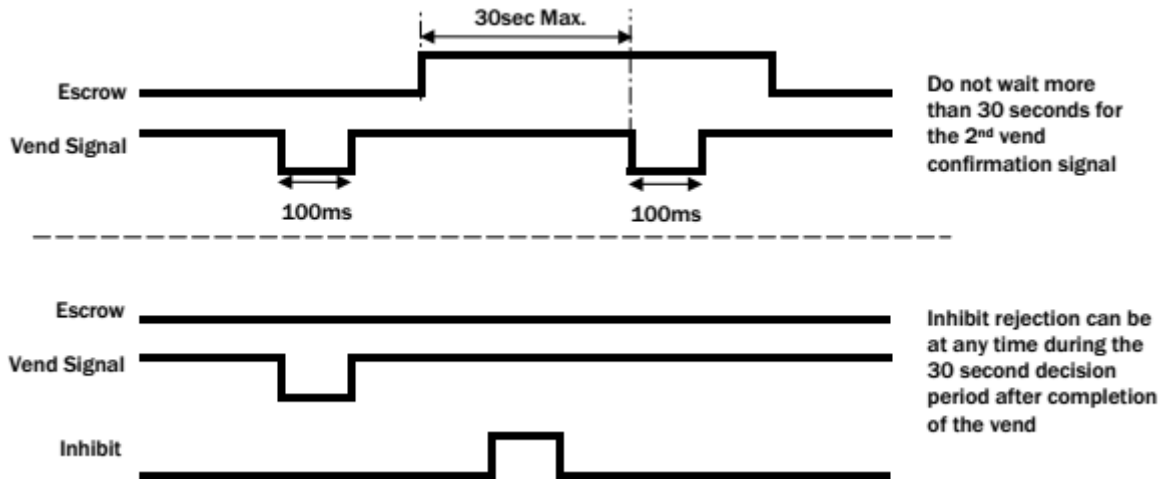

11.7 Low Power Mode Timing Diagram

	Caution!
<p>Low Power Mode can ONLY be used with the above Parallel, Pulse and Binary protocols and only be enabled by correctly completing the configuration cards or Validator Manager program</p>	

Low Power Mode can be used with all none serial communication protocols to reduce the power consumption of the BV20 when idle. When the BV20 is in this state the current consumption is reduced to approximately 1.2mA. The BV20 goes into low power mode approximately 4 seconds after the validator is powered up and remains in this state until a note is entered (Time A). Following a note insertion the BV20 returns to Low Power mode approximately 1 second after the Busy line goes High (After credit is given or note is rejected). (Time B)

Low Power mode uses 3 control lines: Vend – Pin 1, Inhibit – Pin 5 and Busy – Pin 9

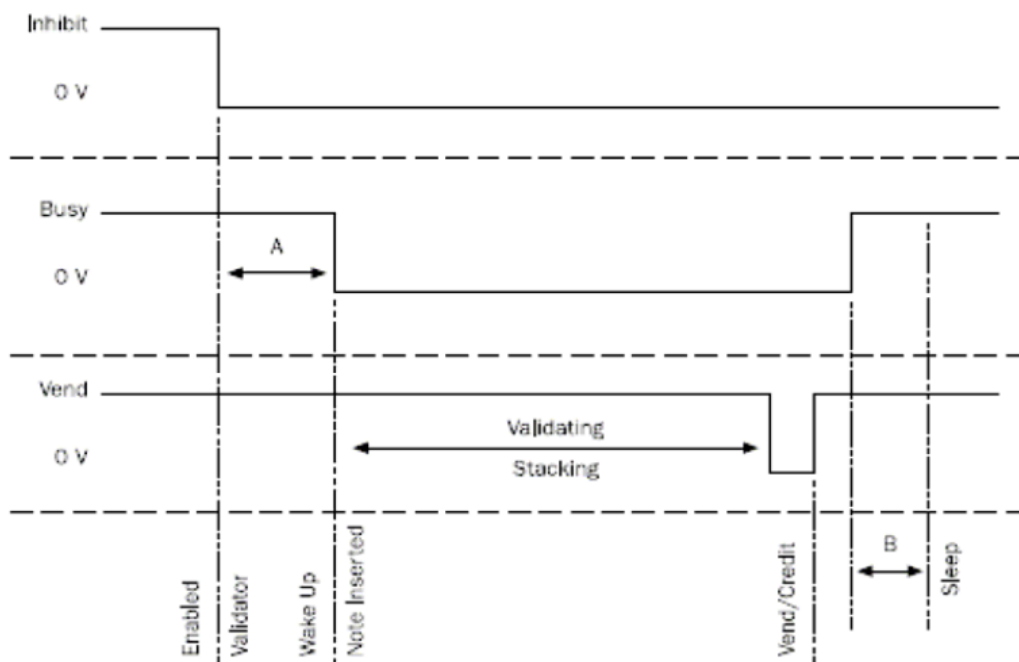

When the Validator is enabled the Inhibit Line is Low and the Busy Line is High. This remains the same until a note is inserted (Time A).

When a note is inserted under the front sensor the BV20 wakes up and the busy line goes low to indicate that the validator is in use. The busy line remains low during the validating and stacking process and once the note has been successfully validated and stacked the vend line goes low to issue the credit.

After the credit is issued the busy line goes high and approximately 1 second after the busy line goes high (Time B) the BV20 goes back into low power mode.



11.8 File Naming Convention

EUR01207_BV002004182328000_IF_01.bv1

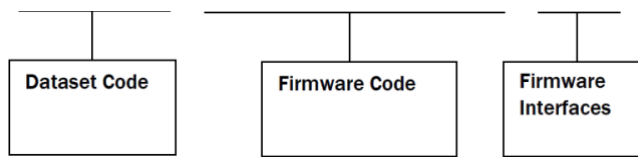

Dataset Code

EUR 01 2 07

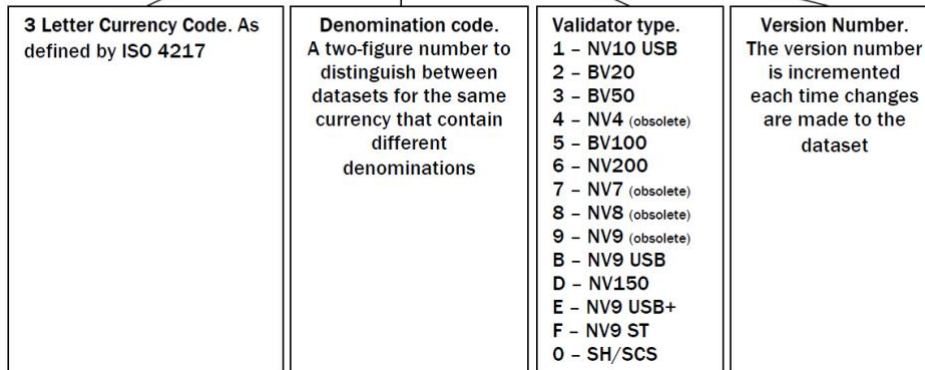

Firmware Code

BV00200 418 2328000

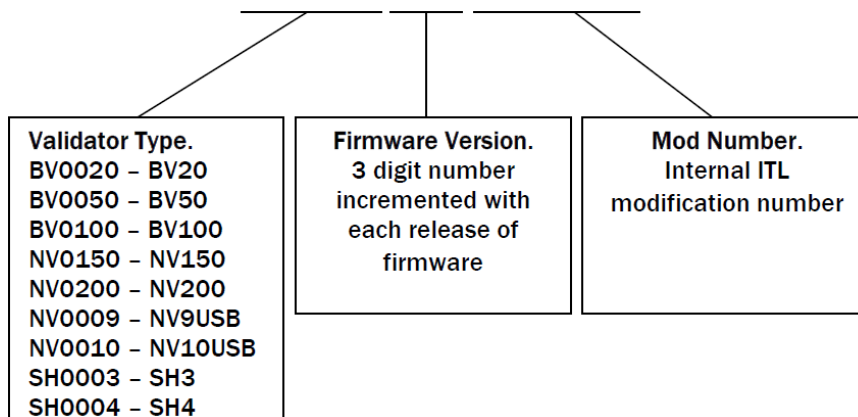

IF_01

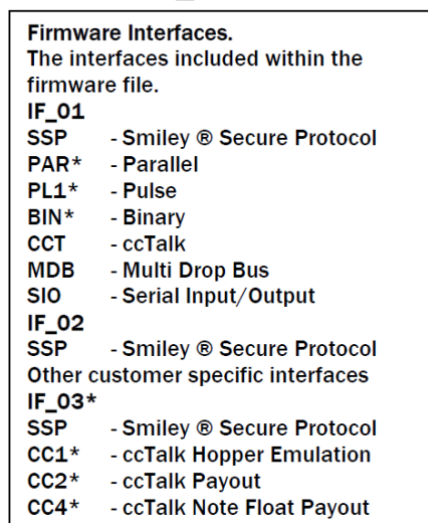

* -Only available for specific validators

